

The Original

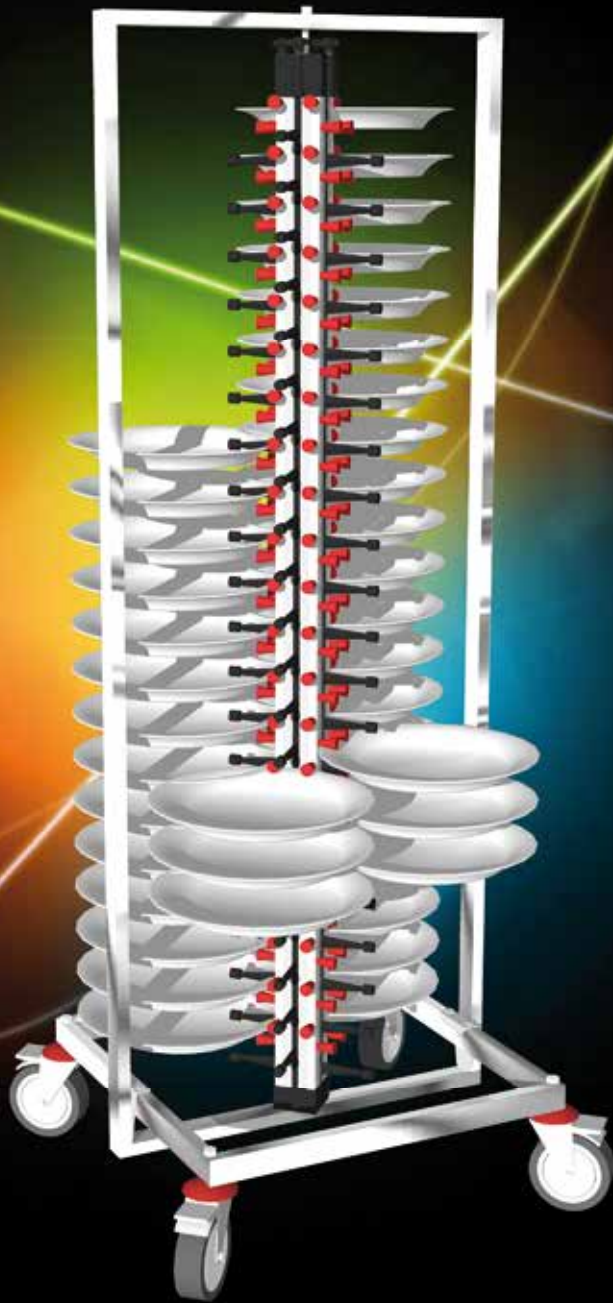

The Plate Mate Catalogue



Table of contents

New models

PM 84	STANDAARD IKE	CODE 110	
PM 84	HEAVY DUTY COLLAPSIBLE	CODE 400	
PM 126	HEAVY DUTY	CODE 426	
PM 48	HEAVY DUTY	CODE 448	
PM 72	HEAVY DUTY	CODE 472	
PM 84	HEAVY DUTY	CODE 484	
WM 12	DESIGNLINE WALLMODELS	CODE 401	STAINLESS STEEL
		CODE 402	RED
		CODE 403	WHITE
		CODE 404	BLACK
		CODE 405	NANO RED
		CODE 406	NANO ORANGE
		CODE 407	NANO YELLOW
		CODE 408	NANO GREEN
		CODE 409	NANO BLUE
WM 14	BOTTLE HOLDER	CODE 414	STAINLESS STEEL
		CODE 415	WHITE
ST 14	BOTTLE HOLDER STANDARD	CODE 424	STAINLESS STEEL
		CODE 425	WHITE

The Plate Mate Catalogue





PM 84

STANDAARD IKE



CODE
110

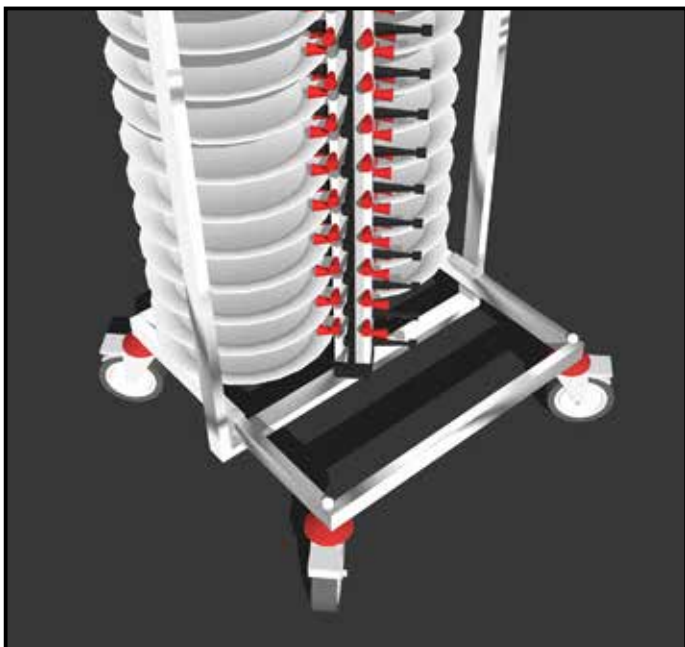
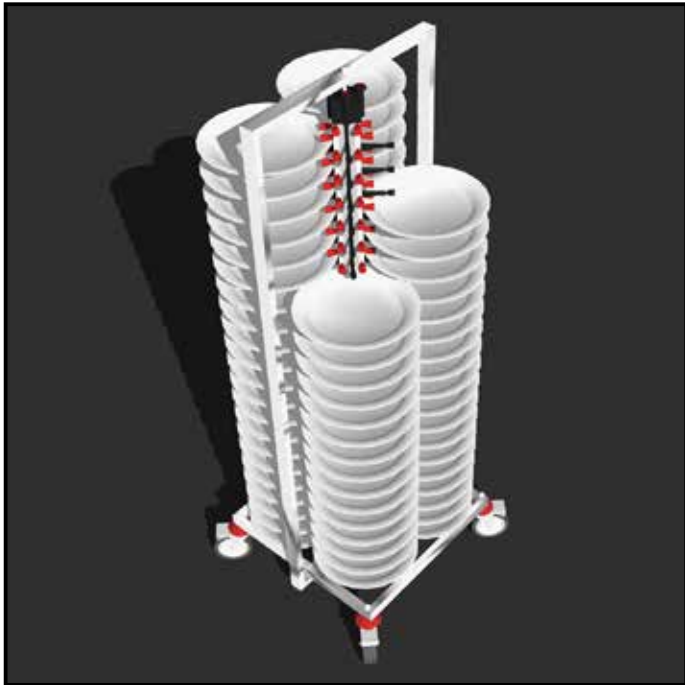
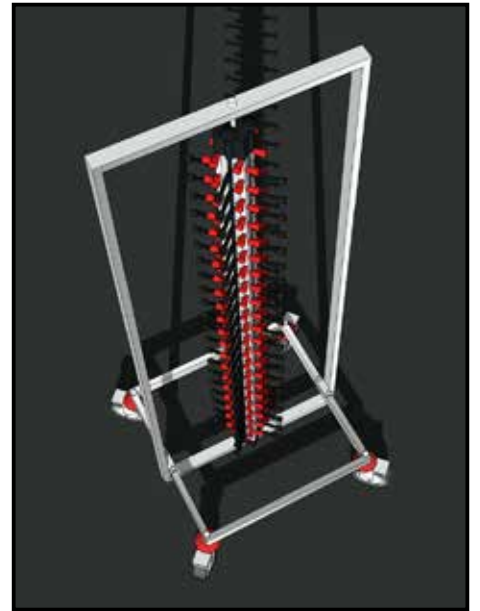

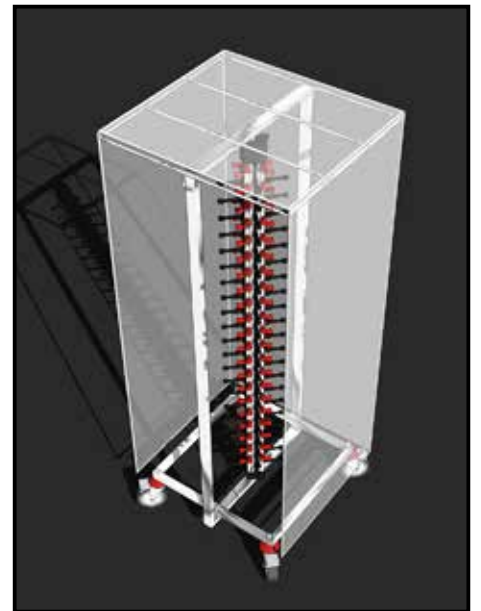
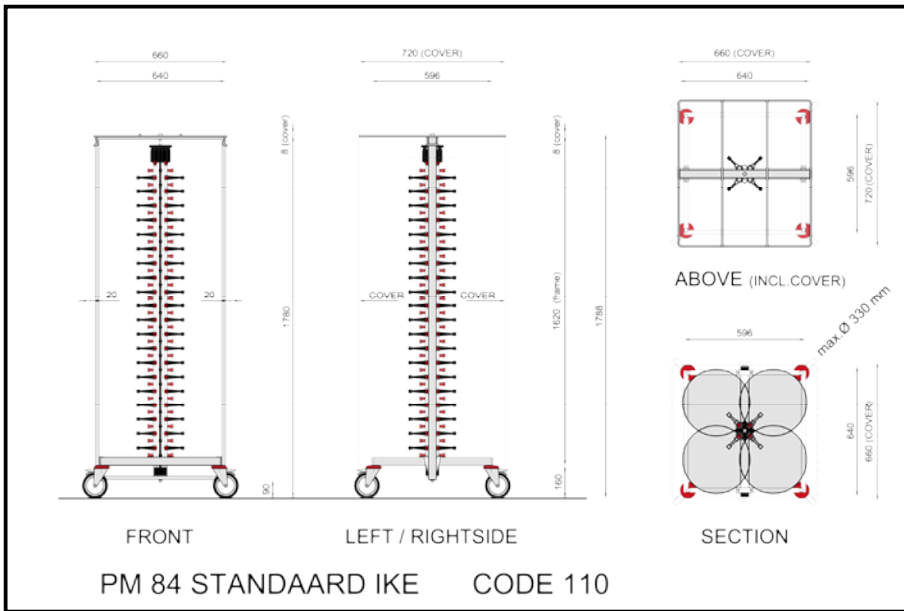

CAPACITY:
 (4 X 21) = 84 PLATES

TOTAL HEIGHT (incl. cover):
 1788 mm

FRAME: 100% STAINLESS STEEL

SIZE: (incl. cover):
 720 x 660 mm

WHEELSIZE:
 125 mm

MAX DIAMETER PLATES:
 33 cm

TOTAL WEIGHT:
 21,5 kg

TARRA:
 4,8 kg

SIZE BOX:
 180 x 75 x 20 cm

PM 84 STANDAARD IKE CODE 110

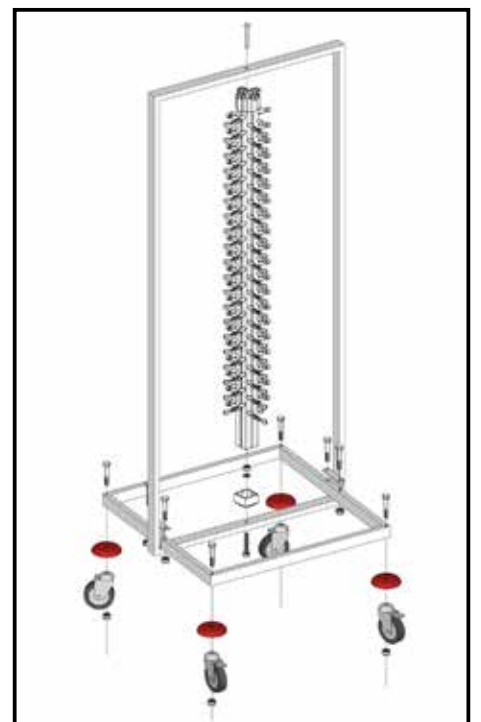
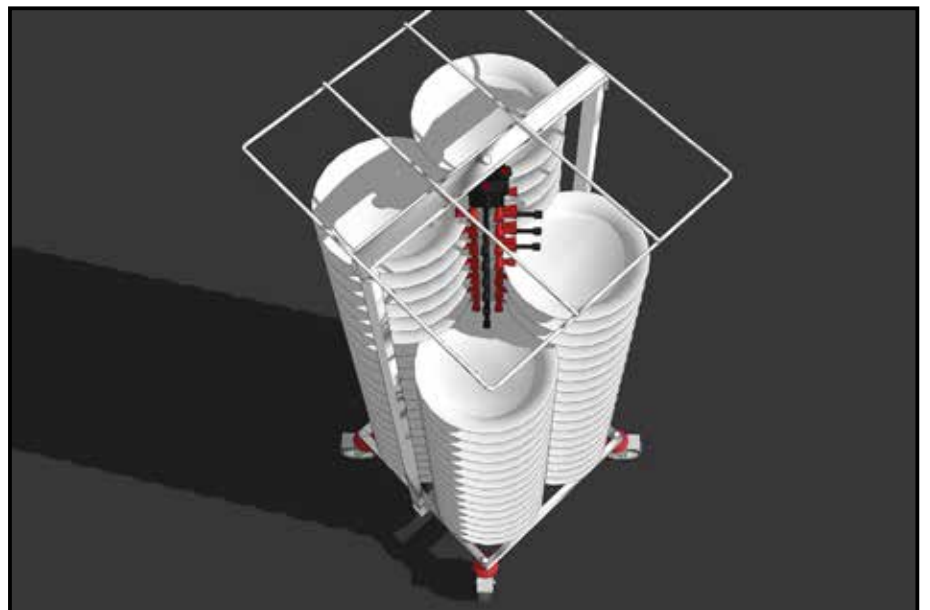

660
640

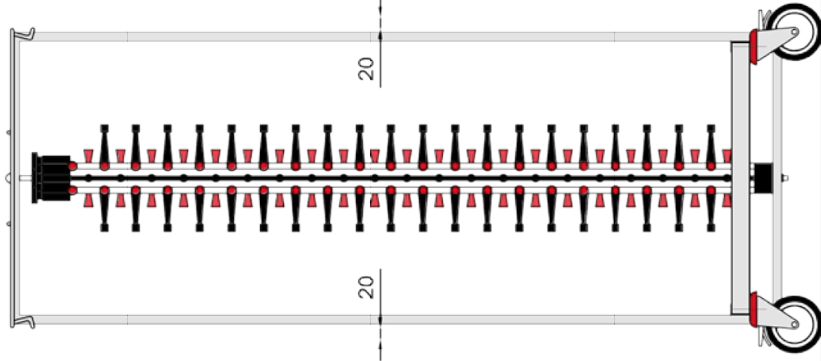

1780
8 (cover)

720 (COVER)
596

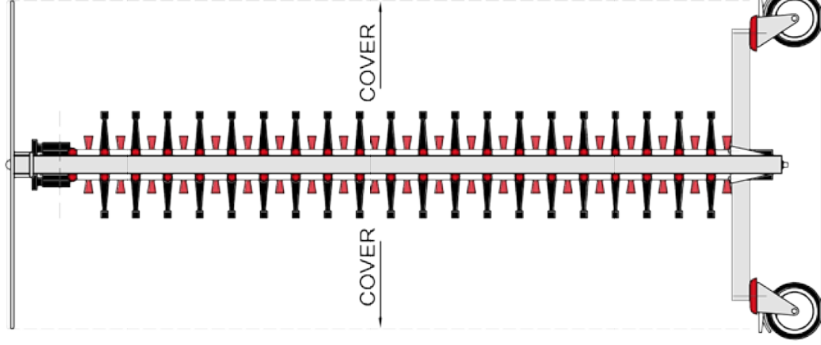

1620 (frame)
8 (cover)

660 (COVER)
640

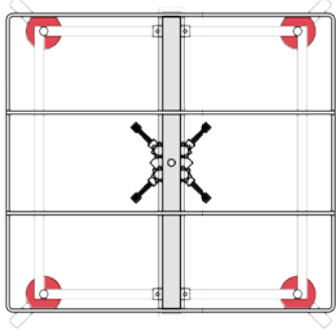

596
720 (COVER)

ABOVE (INCL. COVER)

max. Ø 330 mm

596

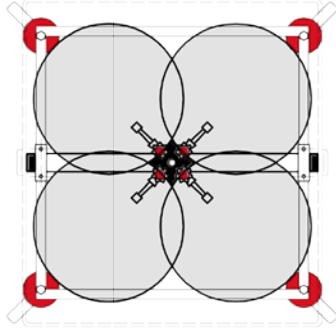

660 (COVER)
640

FRONT

LEFT / RIGHTSIDE

SECTION

PM 84 STANDAARD IKE CODE 110

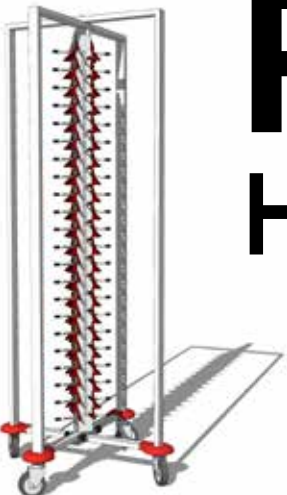



PM 84

HEAVY DUTY

COLLAPSIBLE

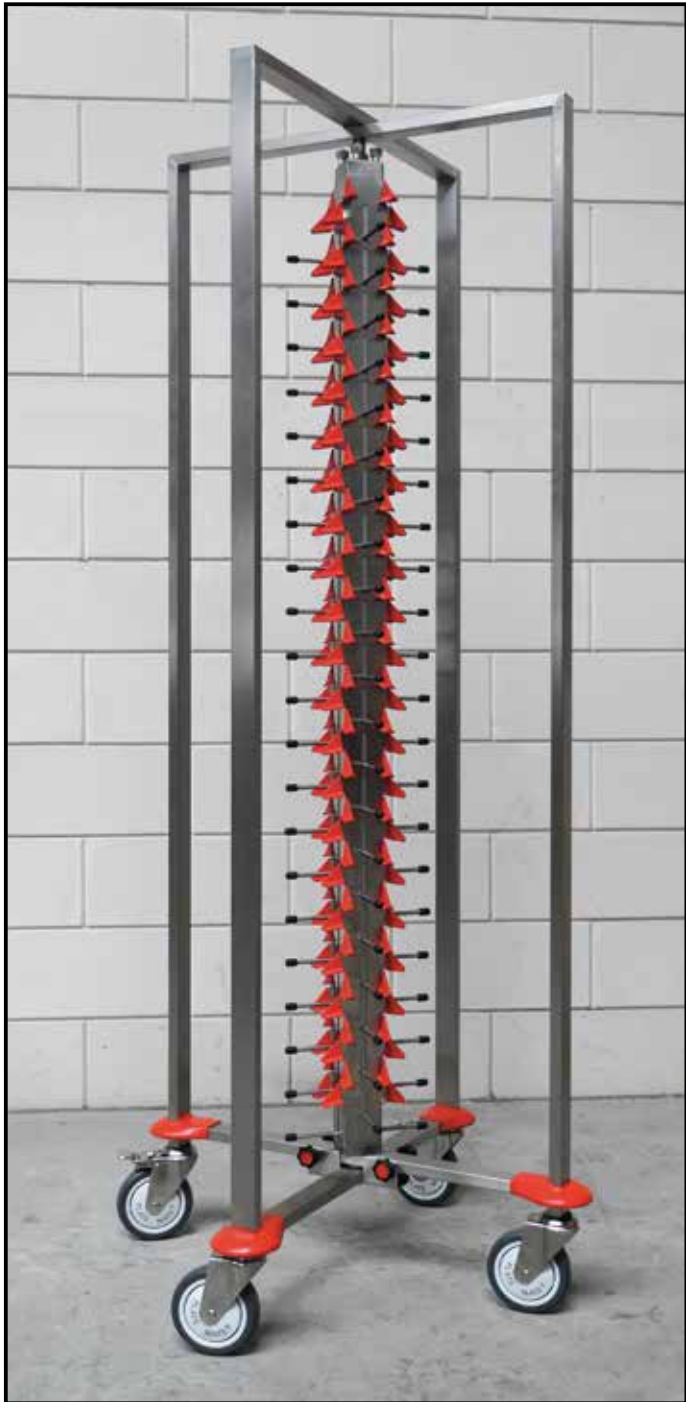
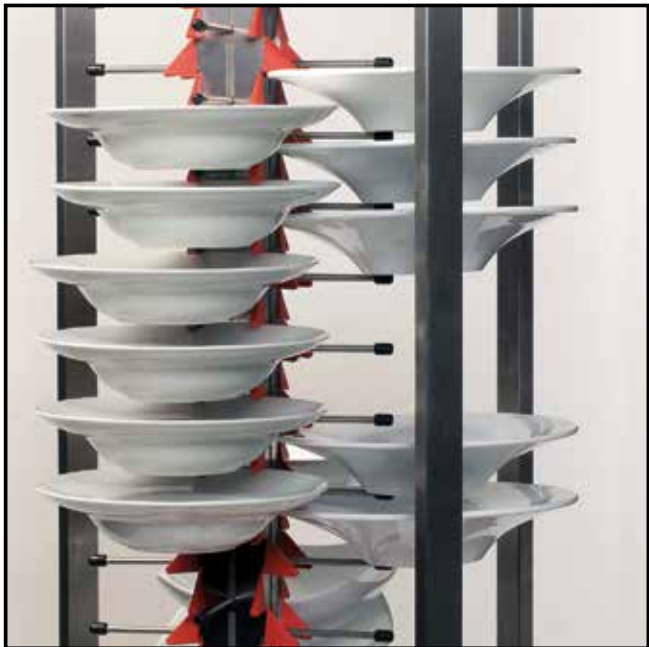
**CODE
400**



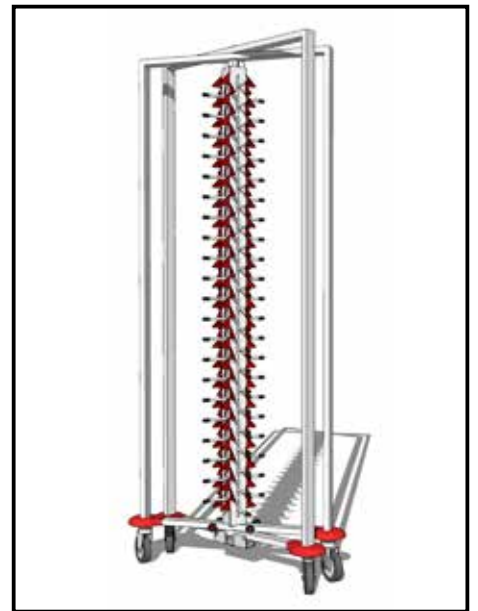
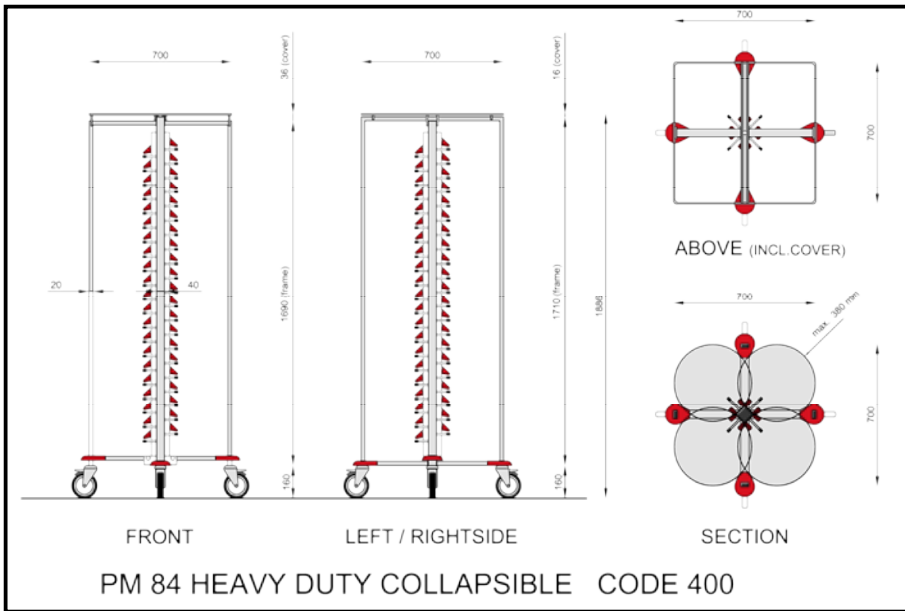

CAPACITY:
 (4 X 21) = 84 PLATES

TOTAL HEIGHT (incl. cover):
 1886 mm

FRAME: 100 % STAINLESS STEEL

SIZE: (incl. cover):
 700 x 700 mm

WHEELSIZE:
 125 mm

MAX DIAMETER PLATES:
 38 cm

NETTO WEIGHT:
 31,5 kg

TARRA WEIGHT:
 4,8 kg

SIZE BOX:
 180 x 75 x 20 cm

PM 84 HEAVY DUTY COLLAPSIBLE CODE 400

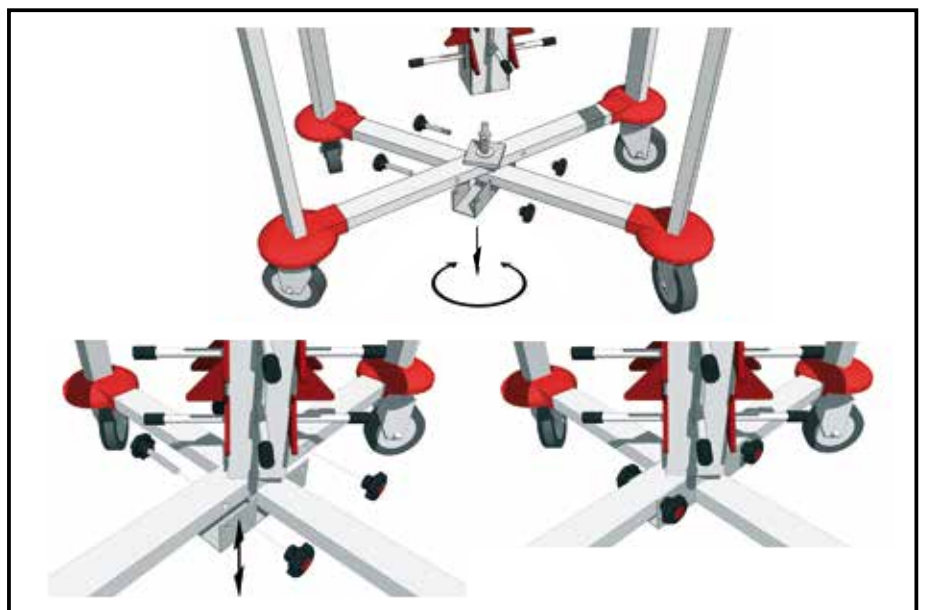

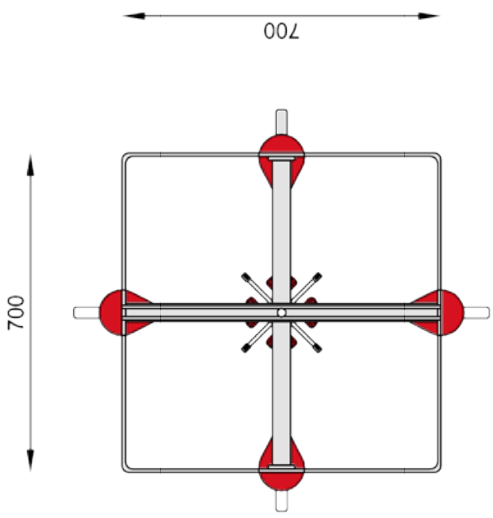

ABOVE (INCL. COVER)

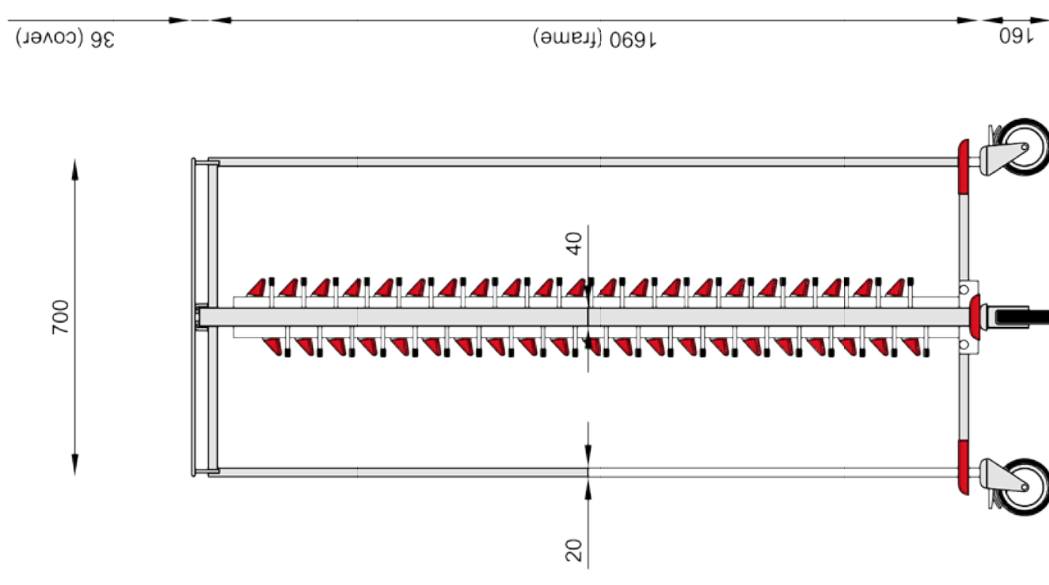
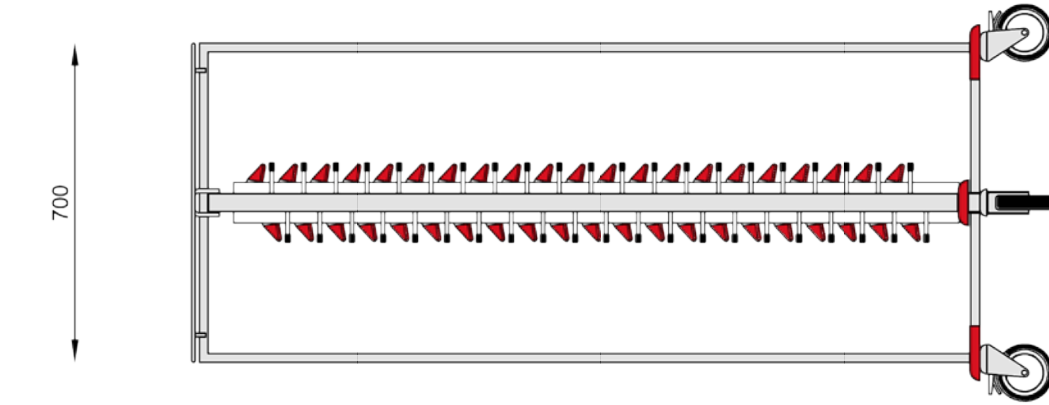
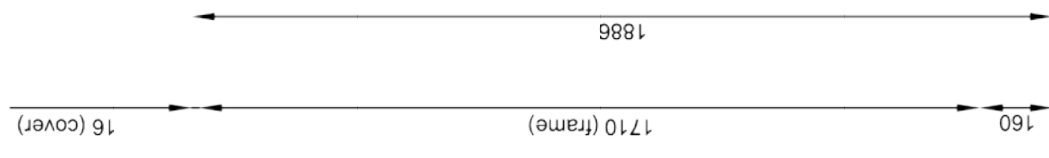
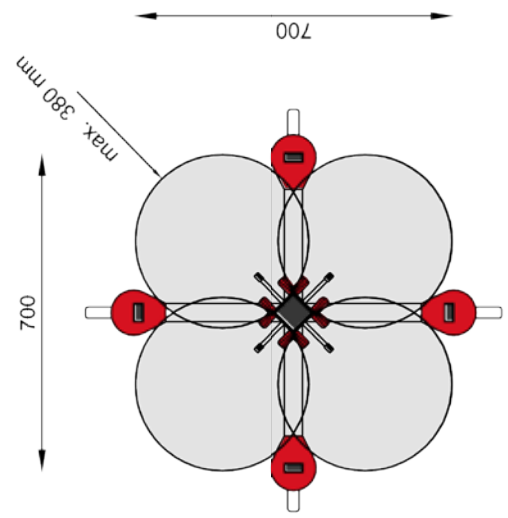

SECTION

LEFT / RIGHTSIDE

FRONT

PM 84 HEAVY DUTY COLLAPSIBLE CODE 400

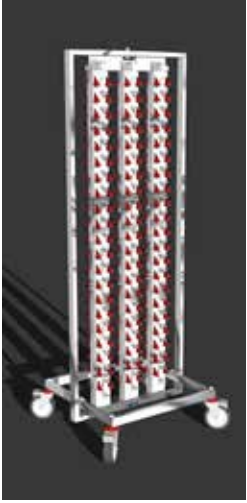

PM 126 HEAVY DUTY



CODE
426

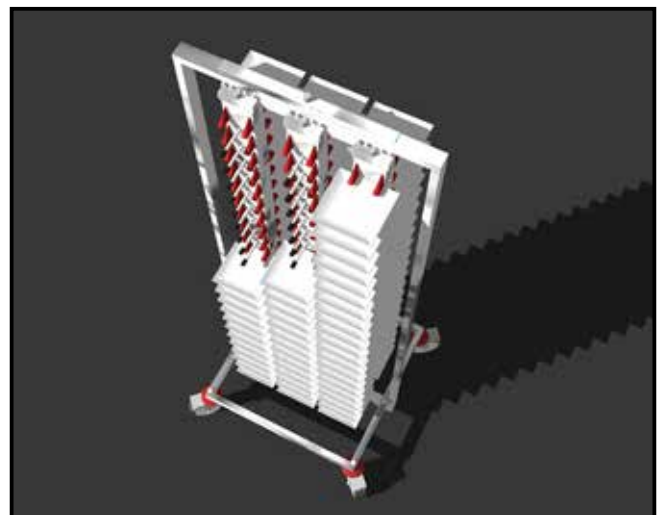
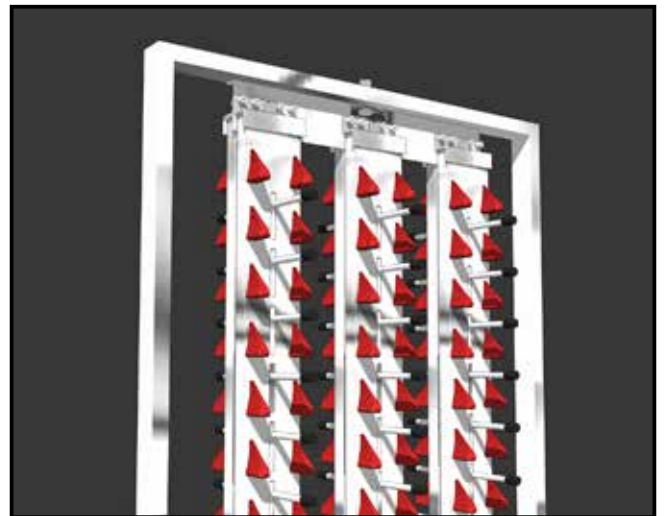
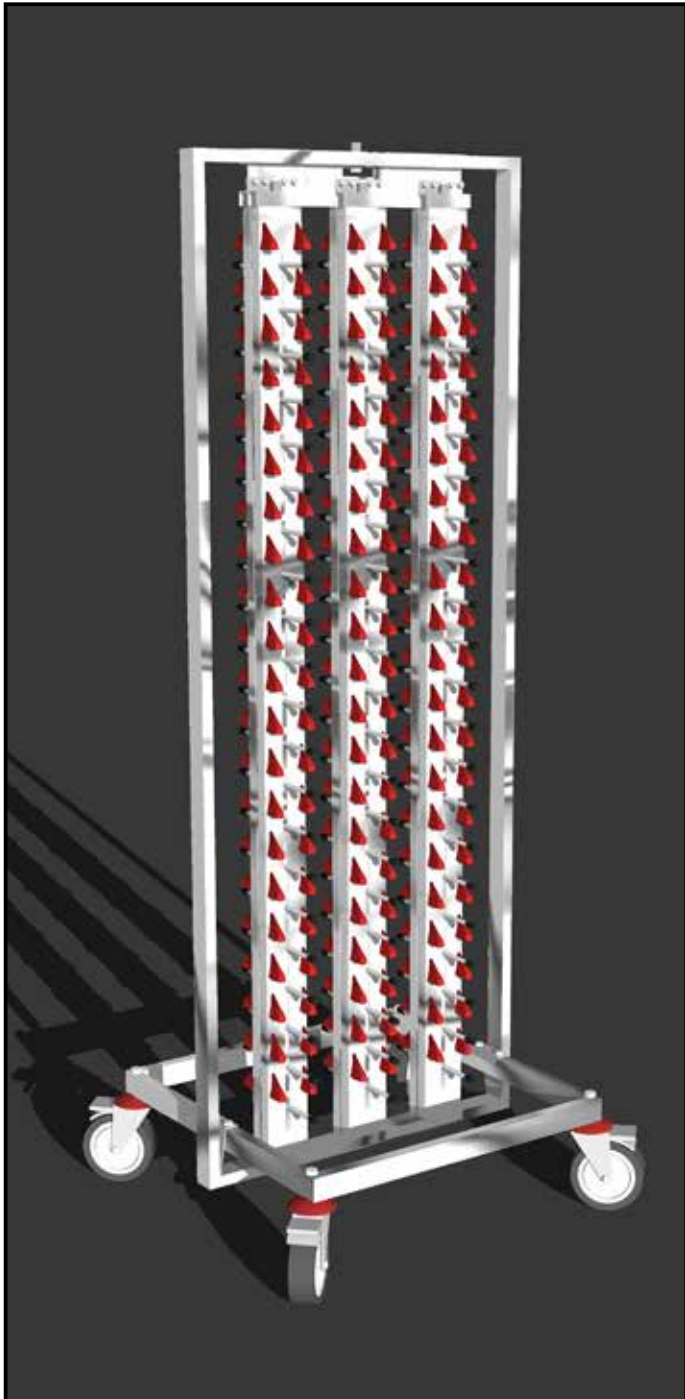
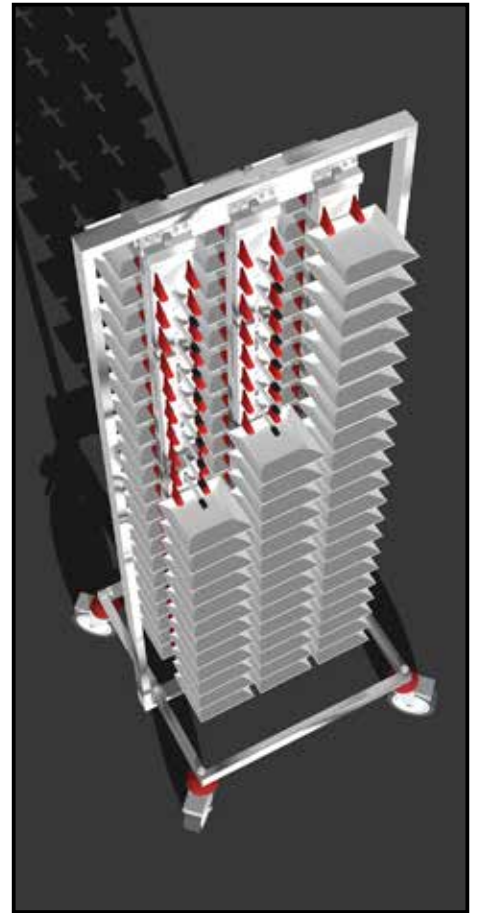

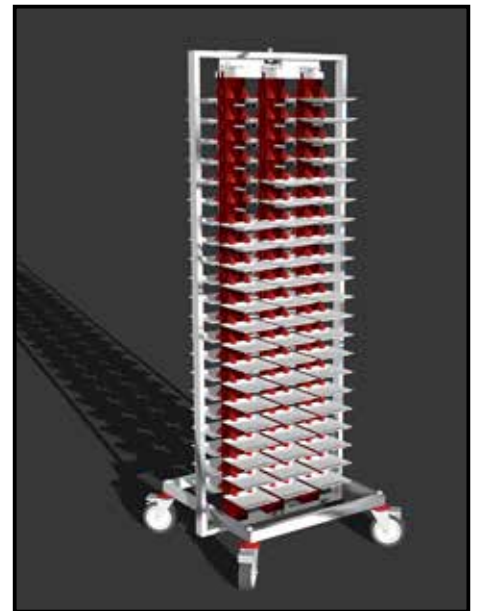
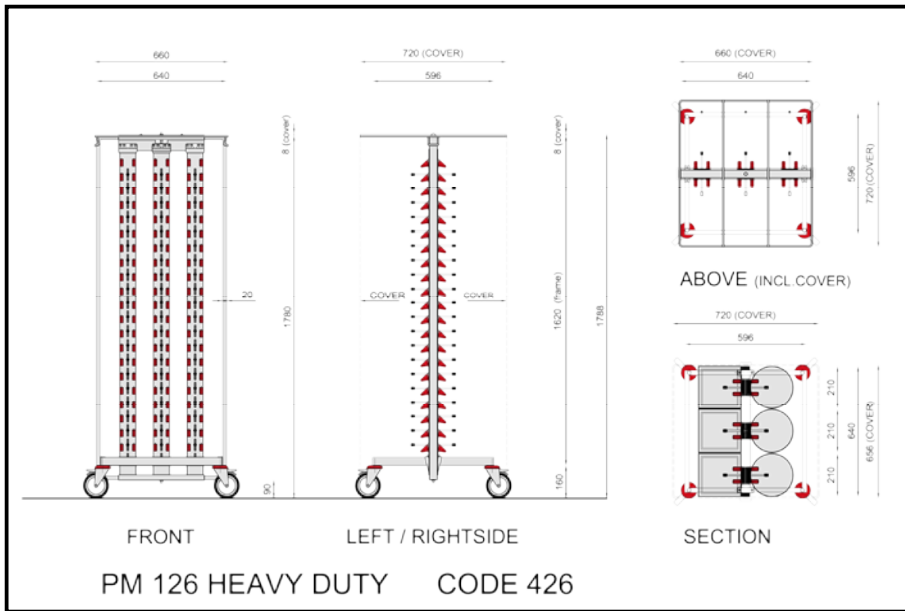

CAPACITY:
(6 X 21) = 126 PLATES

TOTAL HEIGHT (incl. cover):
1788 mm

FRAME: 100 % STAINLESS STEEL
SIZE: (incl. cover):
720 x 660 mm

WHEELSIZE:
125 mm

MAX DIAMETER PLATES:
21 cm

TOTAL WEIGHT:
42,3 (+ 1 wm) kg

TARRA:
4,8 kg

SIZE BOX:
180 x 75 x 20 cm

PM 126 HEAVY DUTY CODE 426

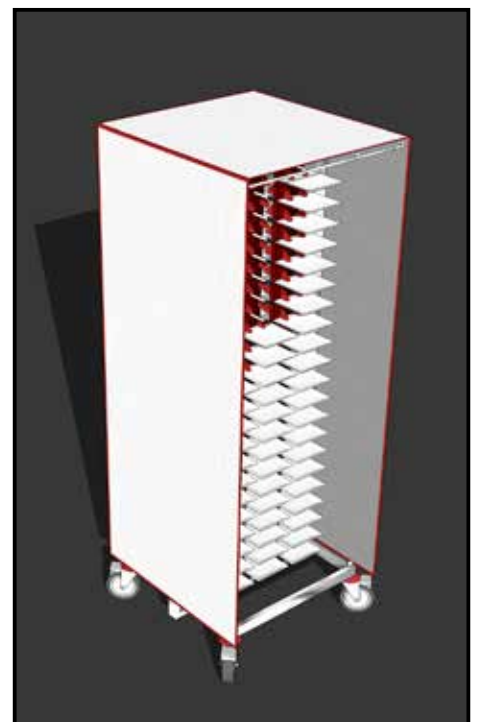
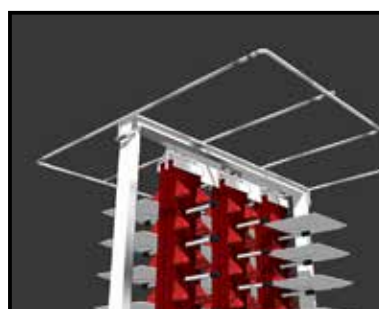
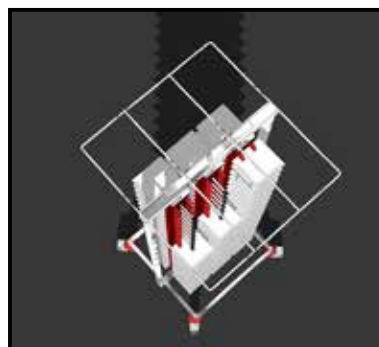
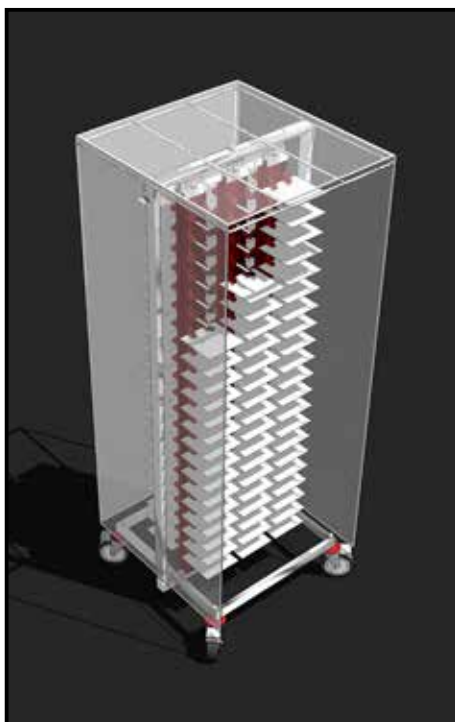
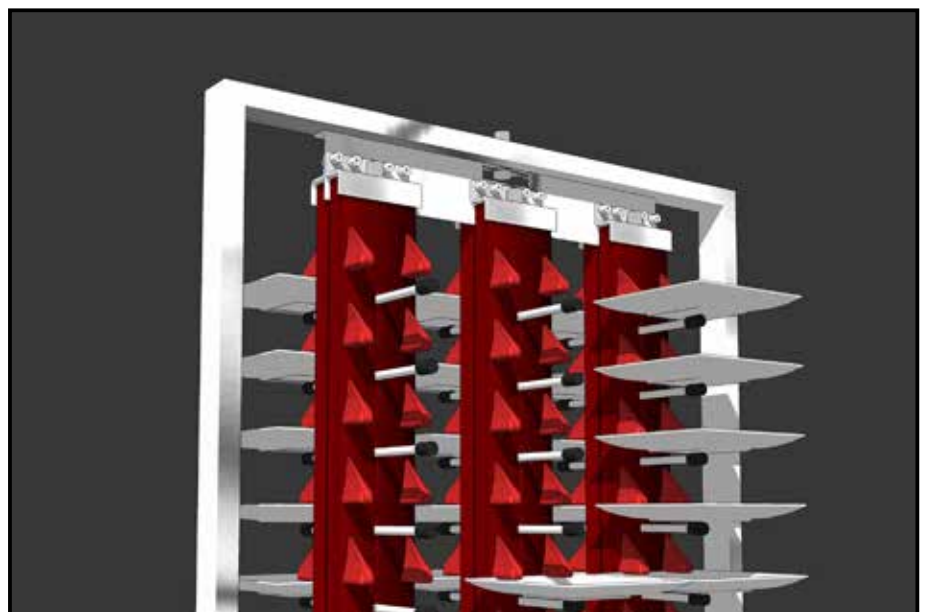

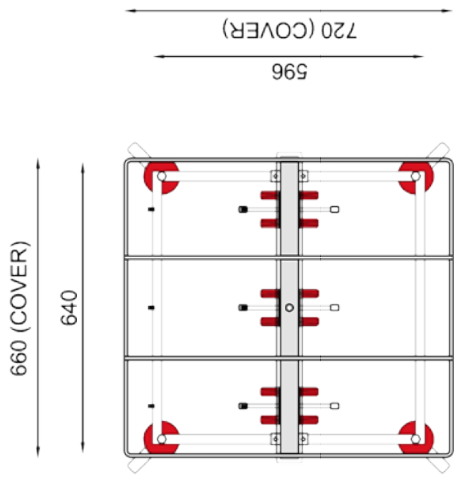
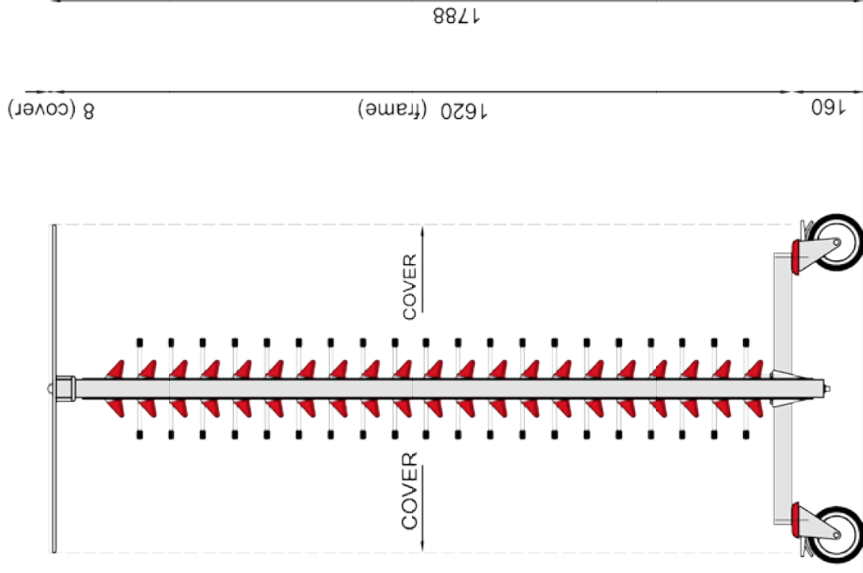
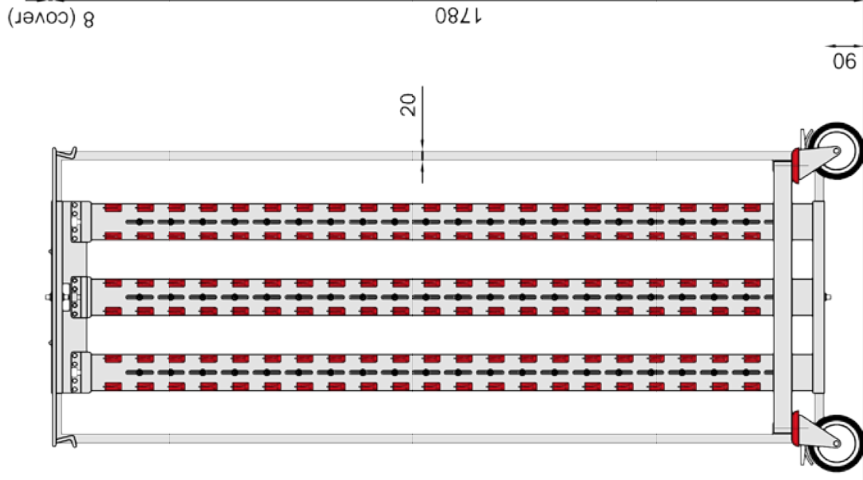

ABOVE (INCL. COVER)

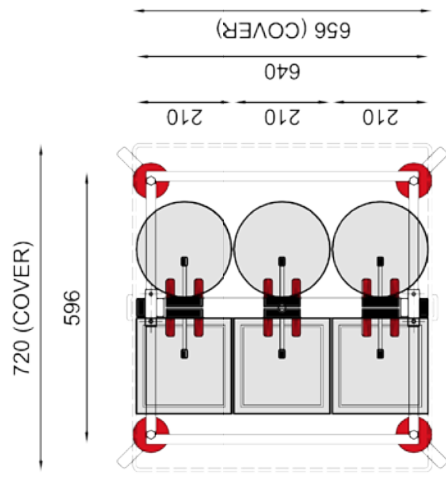

FRONT

LEFT / RIGHTSIDE

SECTION

PM 126 HEAVY DUTY CODE 426



PM 48

HEAVY DUTY



CODE
448

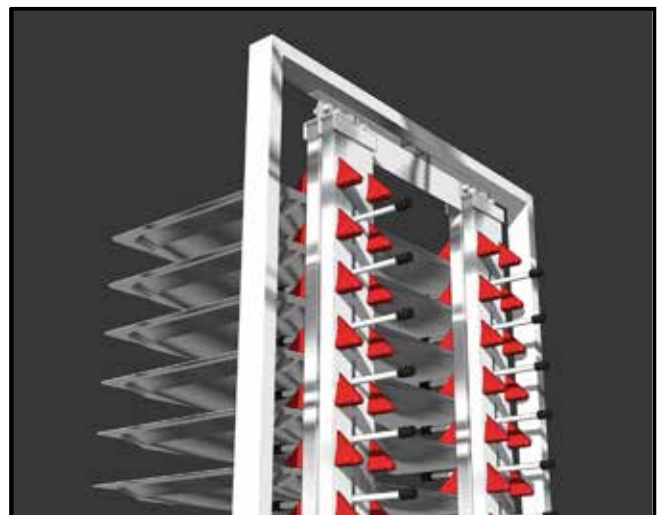
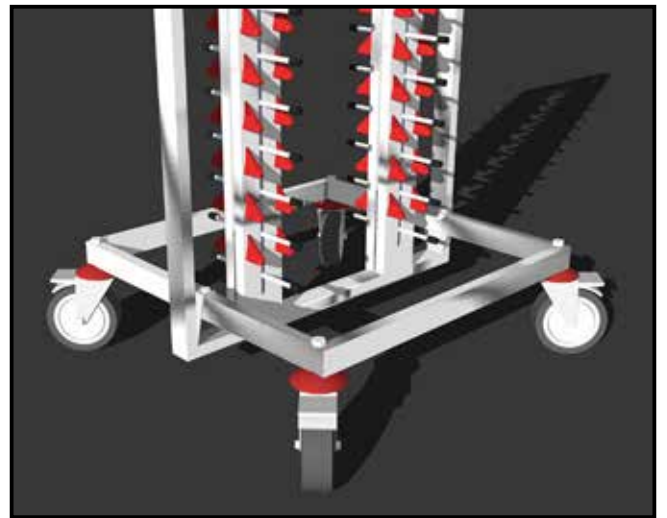
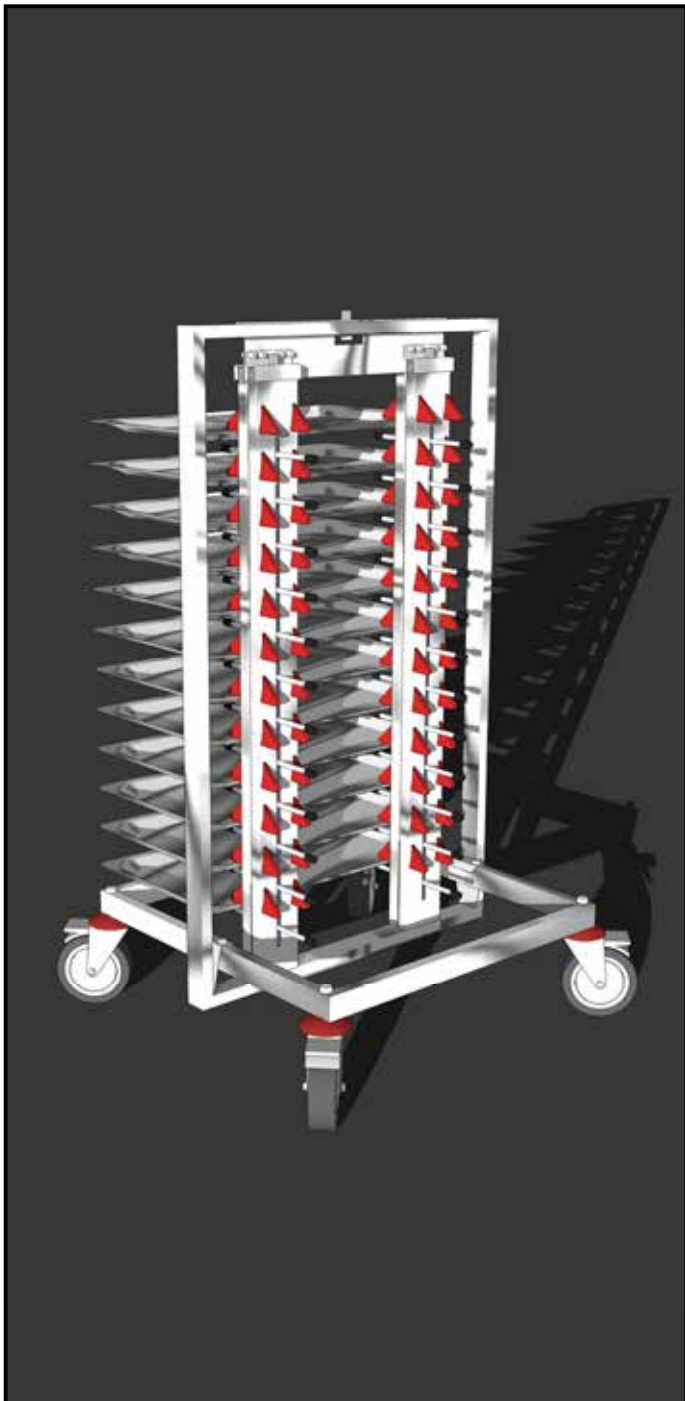
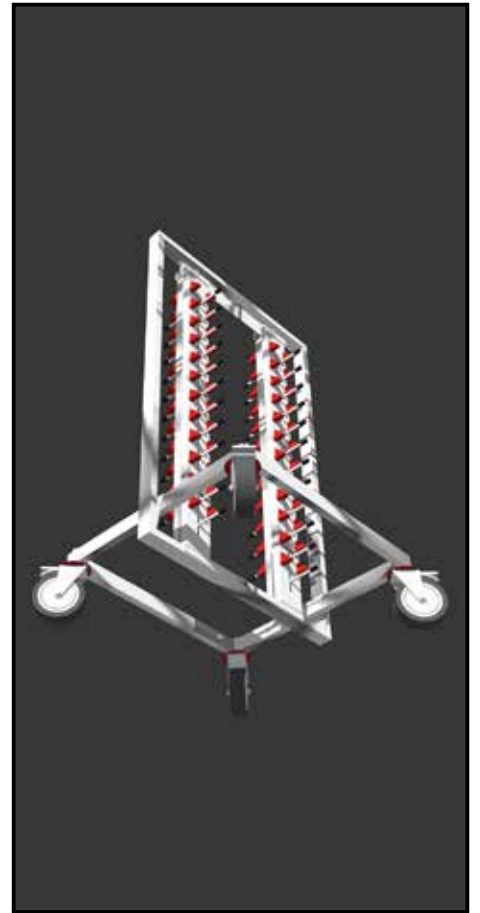

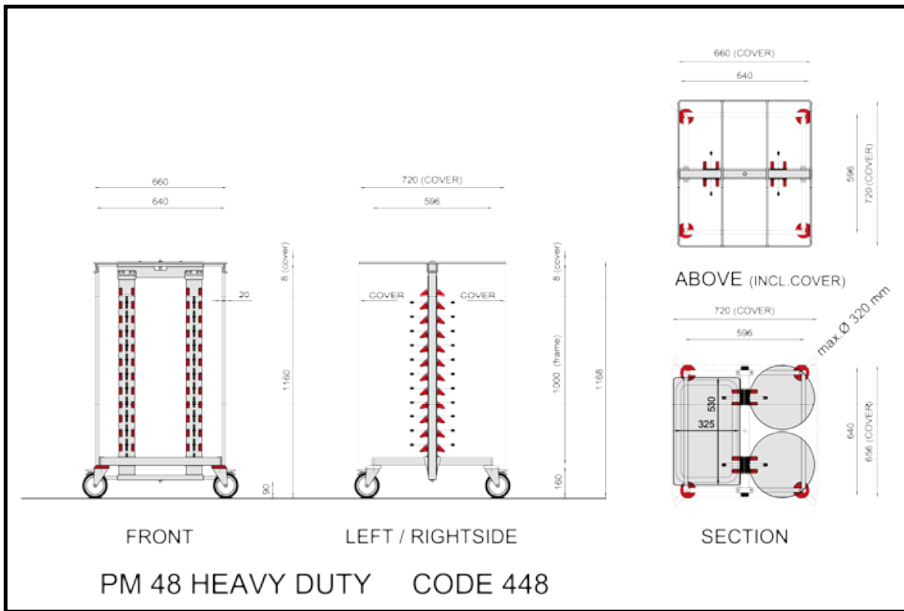

CAPACITY:
 (4 X 12) = 48 PLATES

TOTAL HEIGHT (incl. cover):
 1168 mm

FRAME: 100 % STAINLESS STEEL

SIZE: (incl. cover):
 720 x 660 mm

WHEELSIZE:
 125 mm

MAX DIAMETER PLATES:
 21 cm

TOTAL WEIGHT:
 28 kg

TARRA:
 0,4 kg

SIZE BOX:
 120 x 70 x 20 cm

PM 48 HEAVY DUTY CODE 448

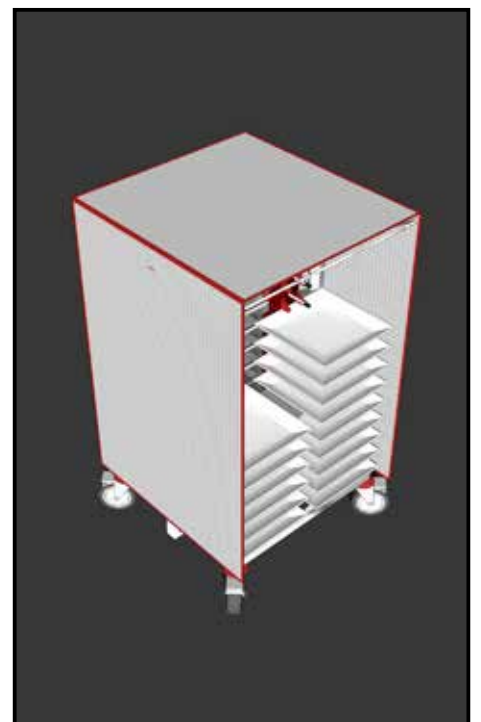
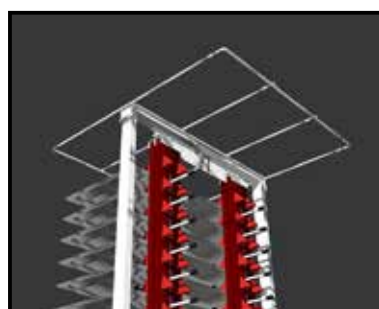
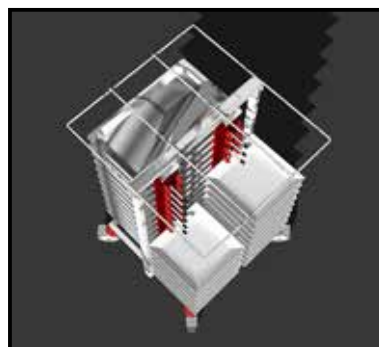
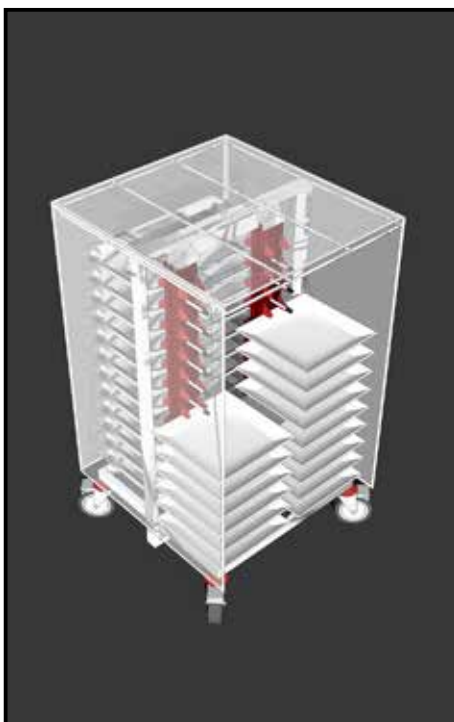
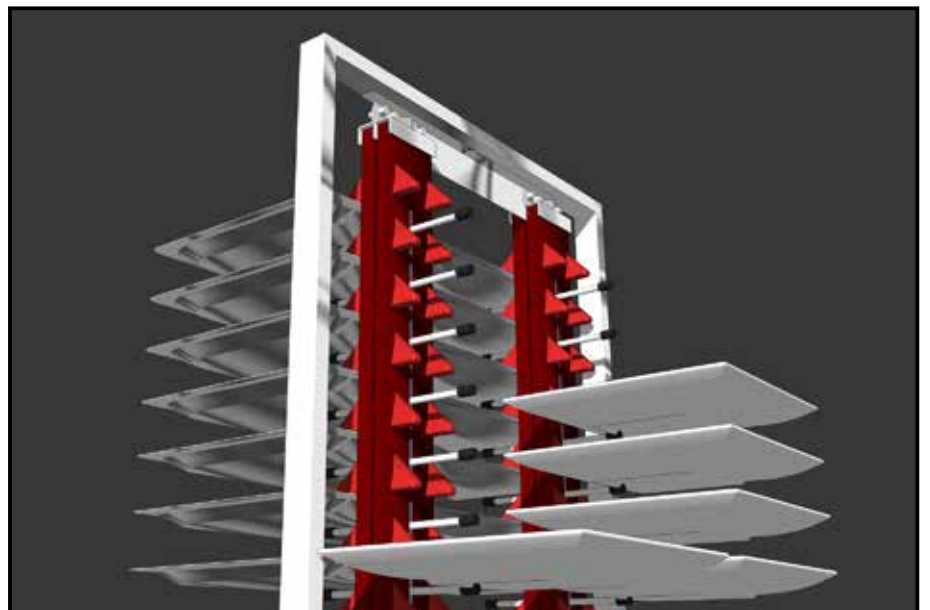

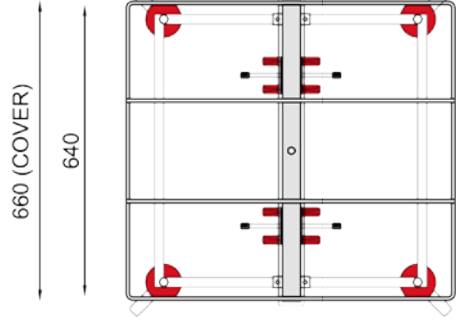

ABOVE (INCL. COVER)

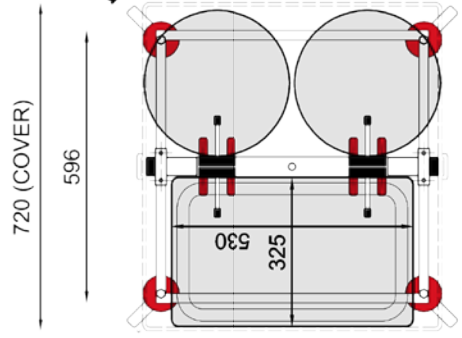

SECTION

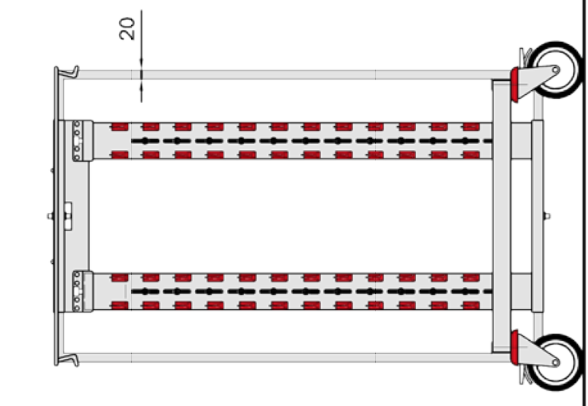
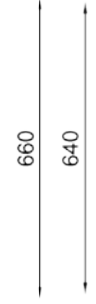
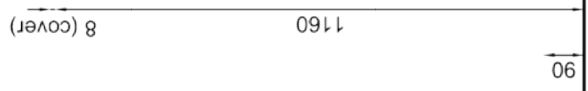
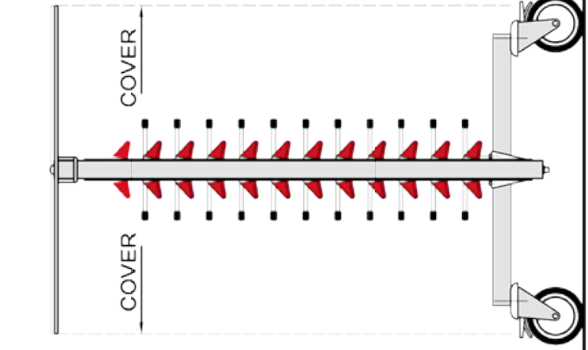
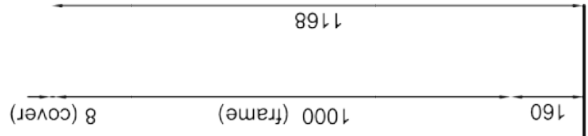

LEFT / RIGHTSIDE

FRONT

PM 48 HEAVY DUTY CODE 448



PM 72

HEAVY DUTY



CODE
472

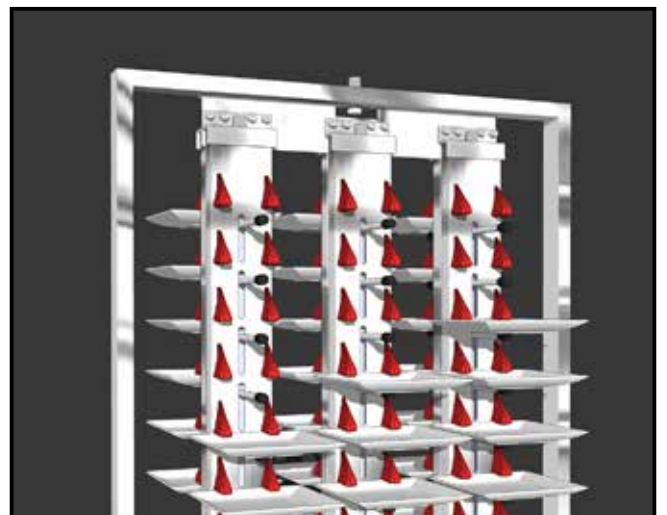
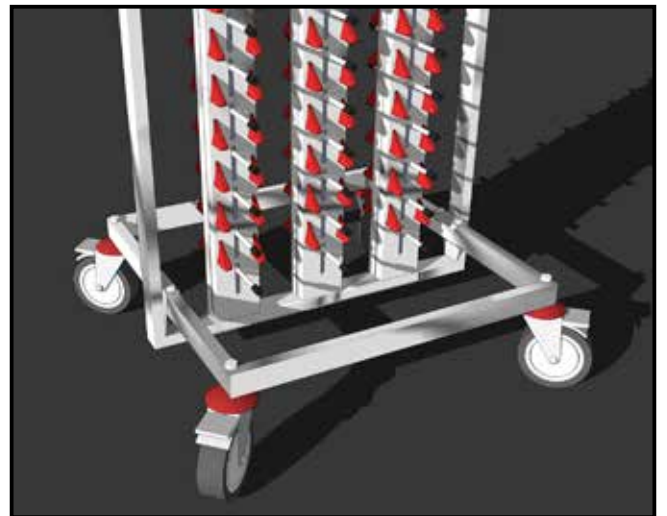
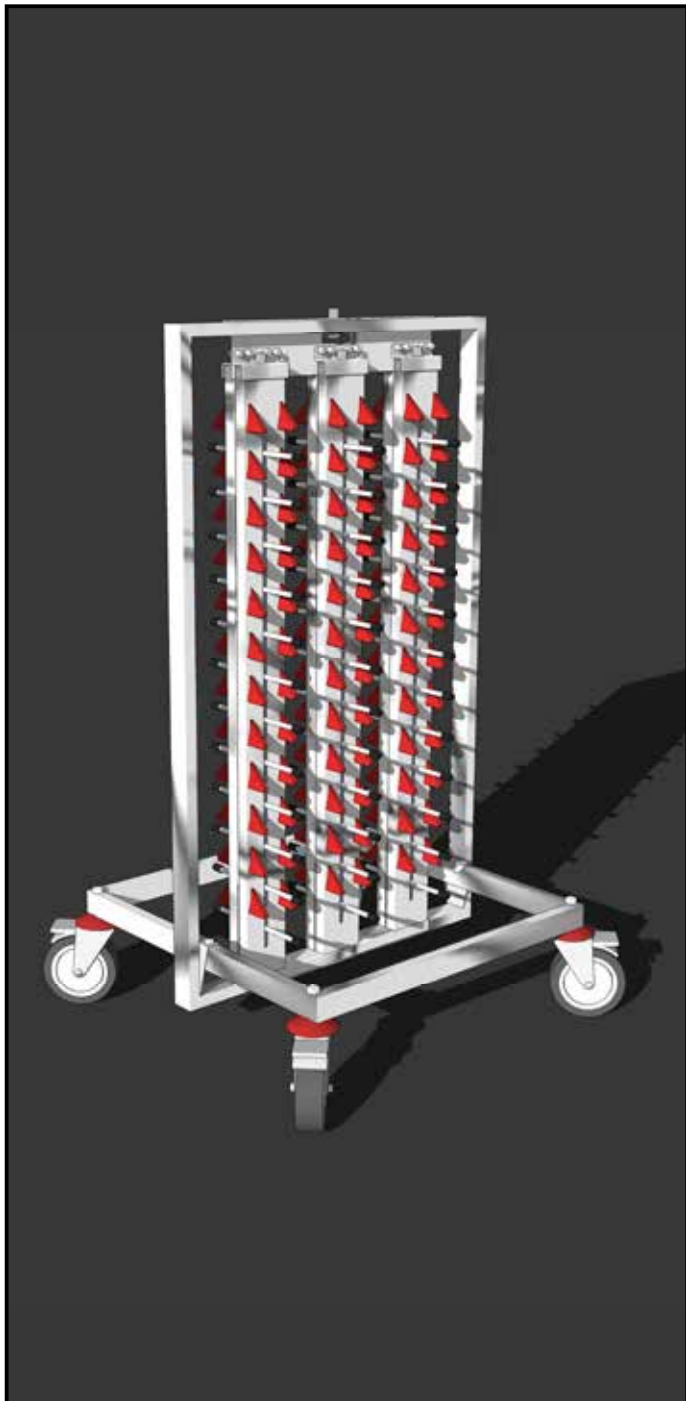

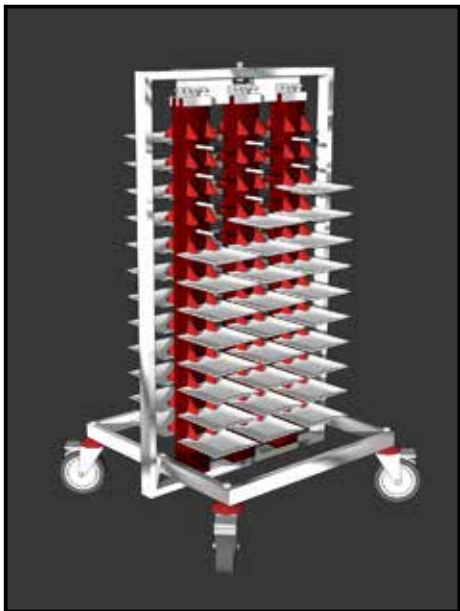
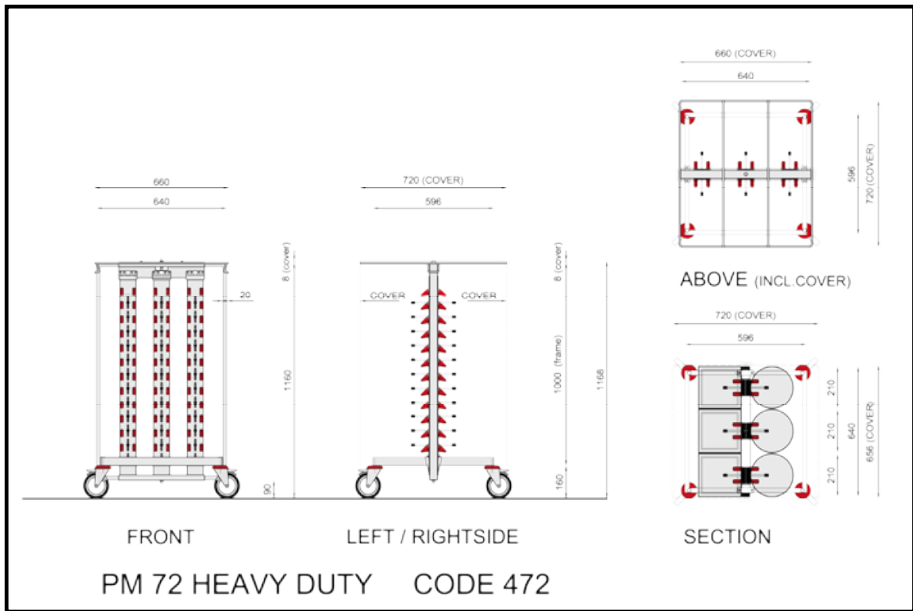

CAPACITY:
(6 X 12) = 72 PLATES

TOTAL HEIGHT (incl. cover):
1168 mm

FRAME: 100 % STAINLESS STEEL

SIZE: (incl. cover):
720 x 660 mm

WHEELSIZE:
125 mm

MAX DIAMETER PLATES:
21 cm

TOTAL WEIGHT:
38 kg

TARRA:
0,4 kg

SIZE BOX:
120 x 70 x 20 cm

PM 72 HEAVY DUTY CODE 472

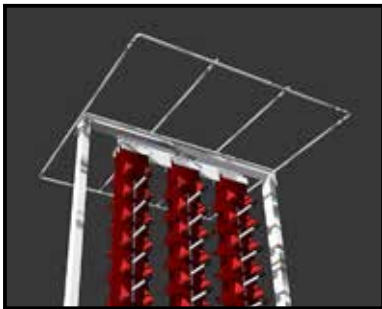
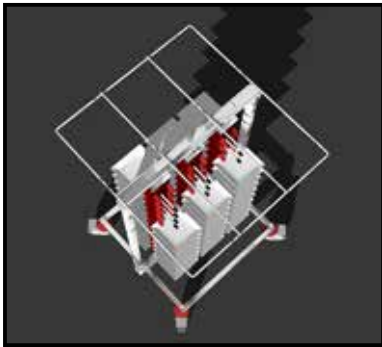
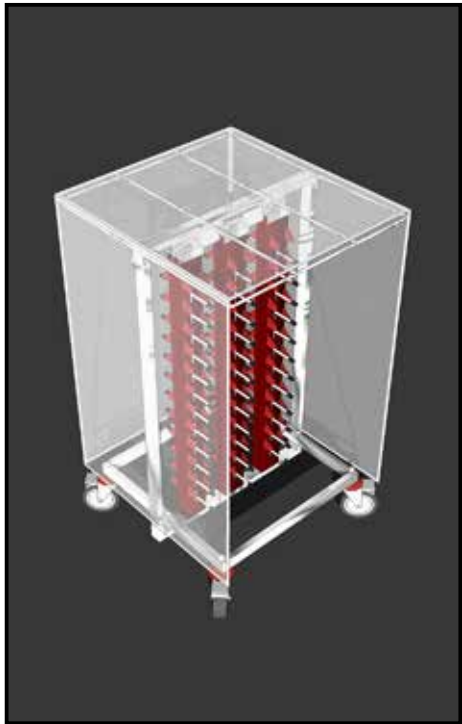
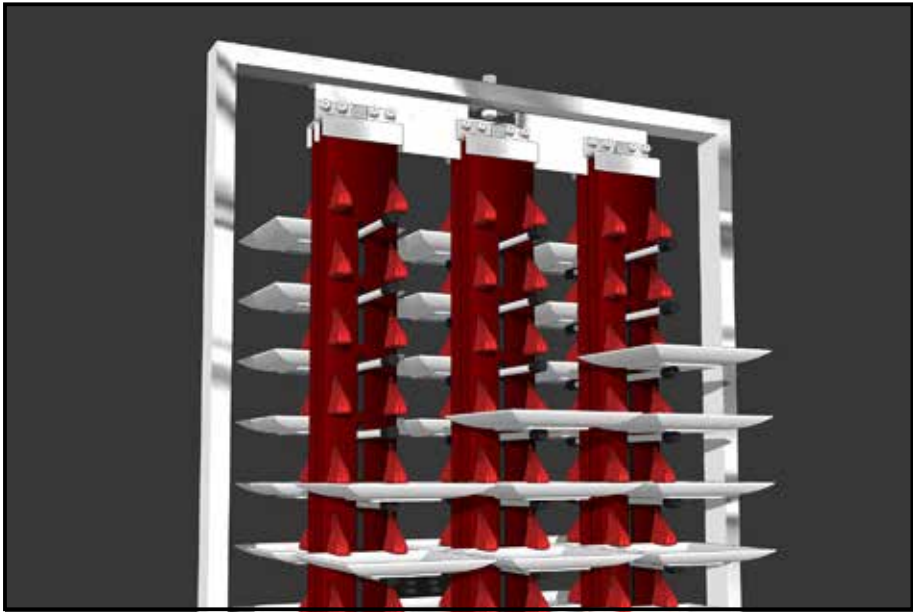

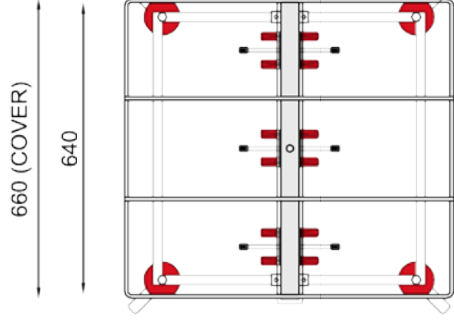

ABOVE (INCL. COVER)

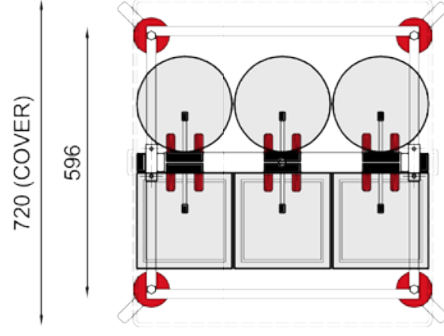

SECTION

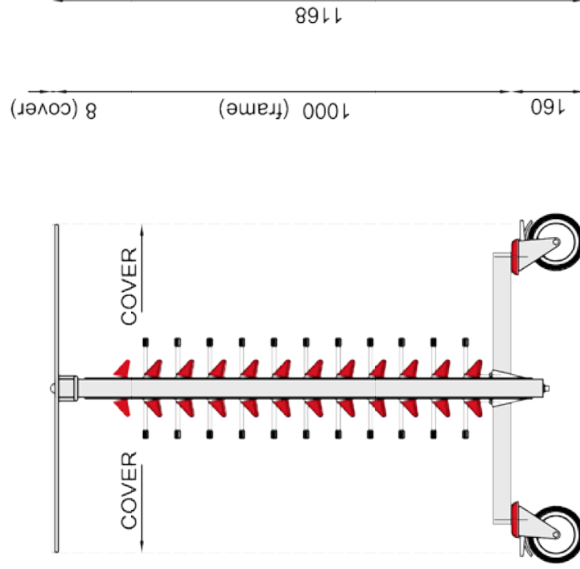

LEFT / RIGHTSIDE

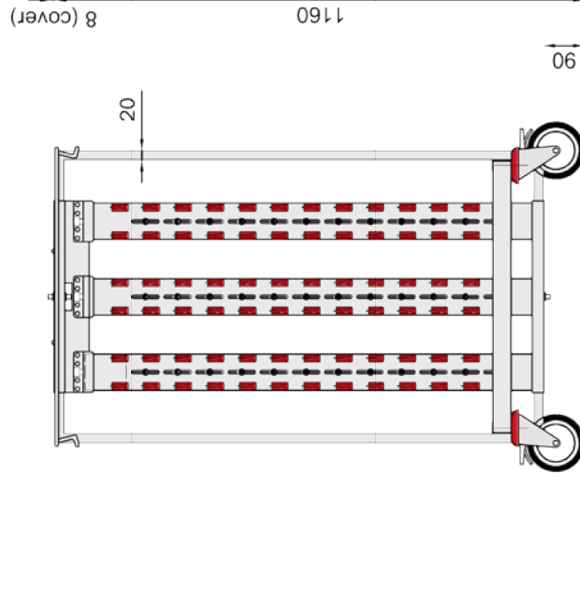
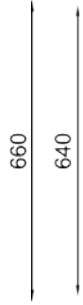

FRONT

PM 72 HEAVY DUTY CODE 472



PM 84

HEAVY DUTY



CODE
484

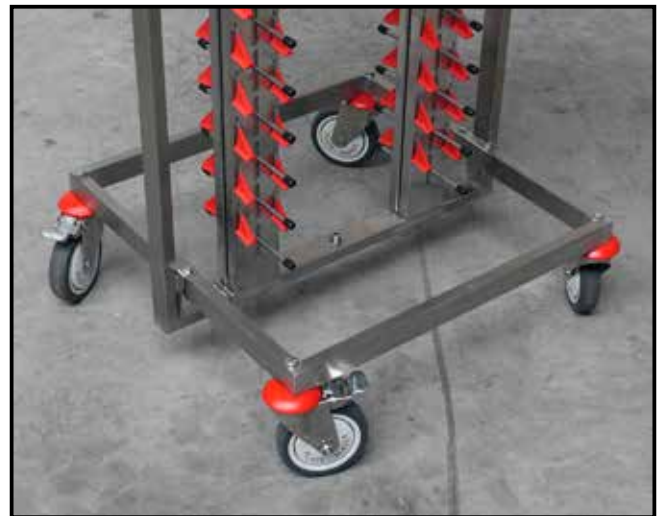

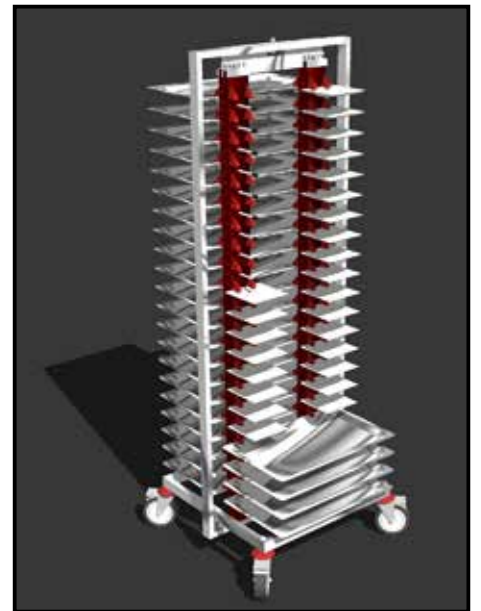
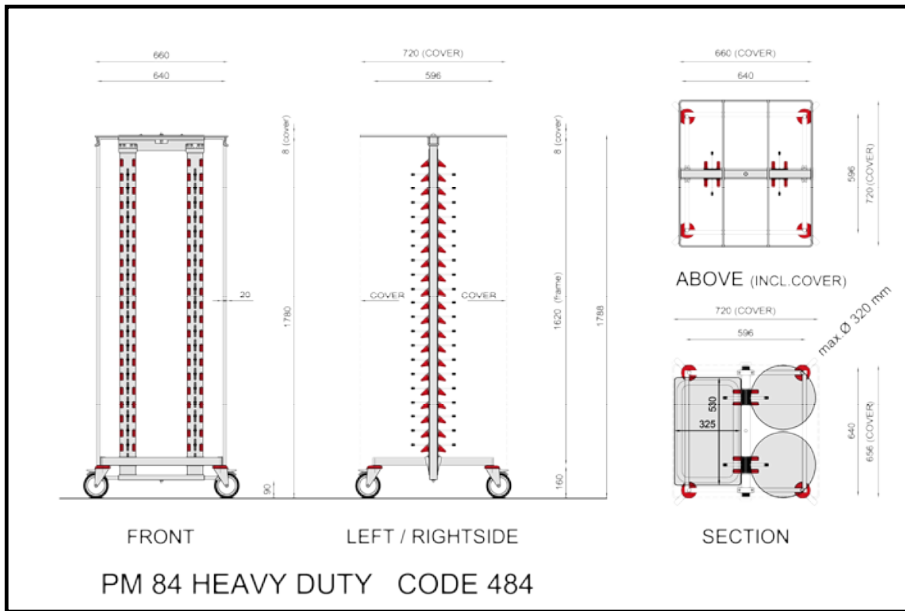

CAPACITY:
(4 X 21) = 84 PLATES

TOTAL HEIGHT (incl. cover):
1788 mm

FRAME: 100 % STAINLESS STEEL

SIZE: (incl. cover):
720 x 660 mm

WHEELSIZE:
125 mm

MAX DIAMETER PLATES:
32 cm

TOTAL WEIGHT:
42,3 kg

TARRA:
4,8 kg

SIZE BOX:
180 x 75 x 20 cm

PM 84 HEAVY DUTY CODE 484

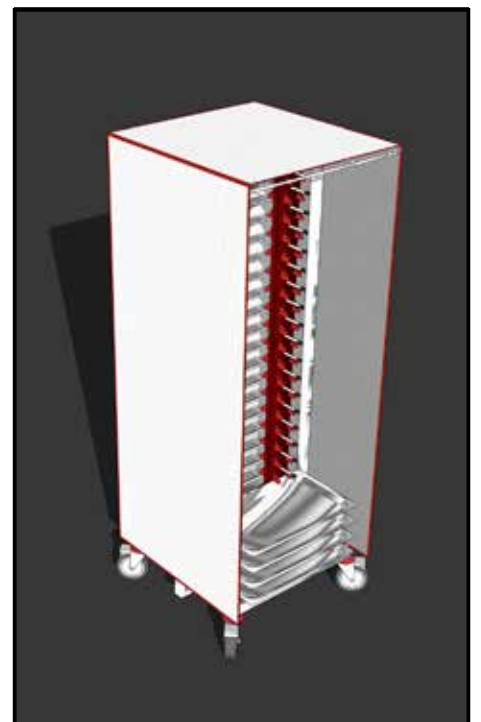
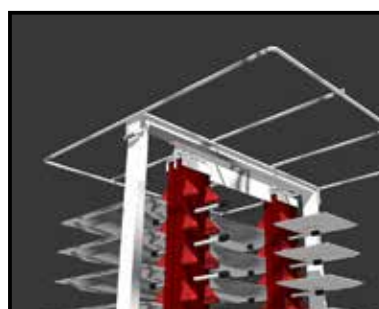
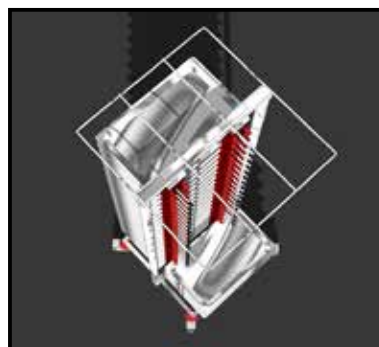
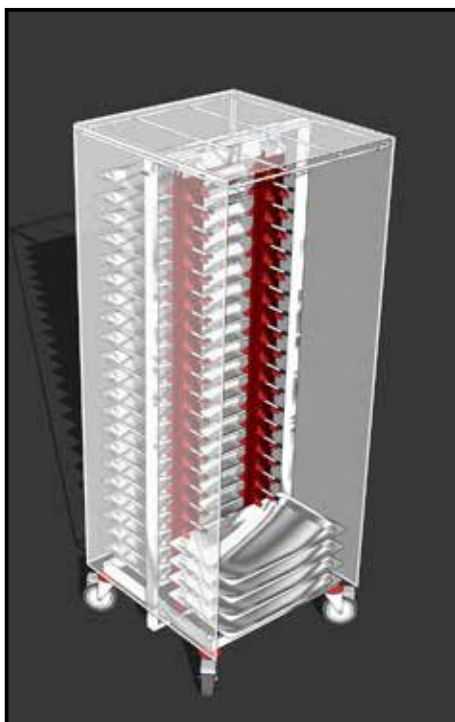
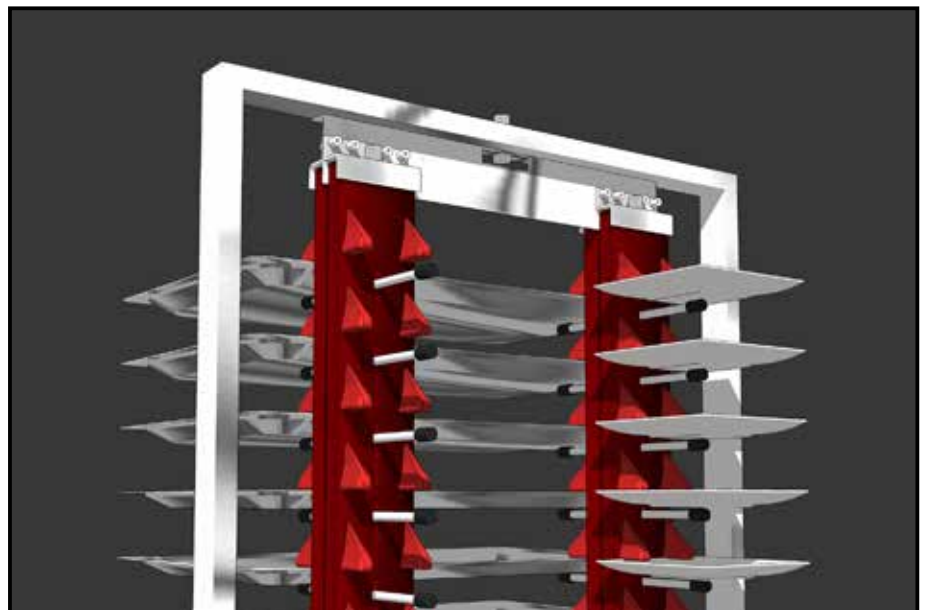

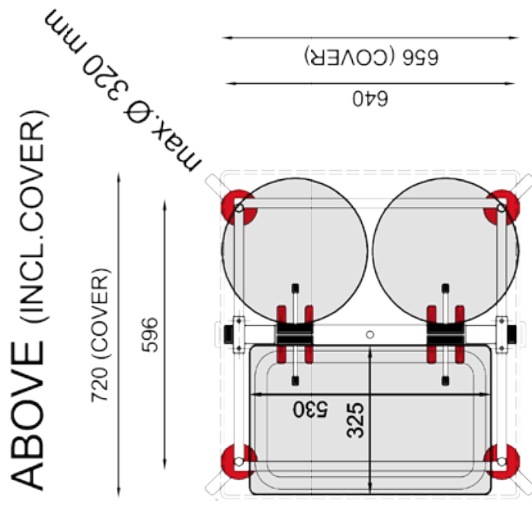
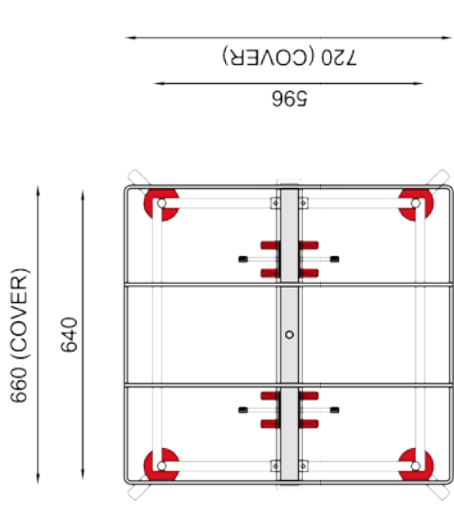

ABOVE (INCL. COVER)

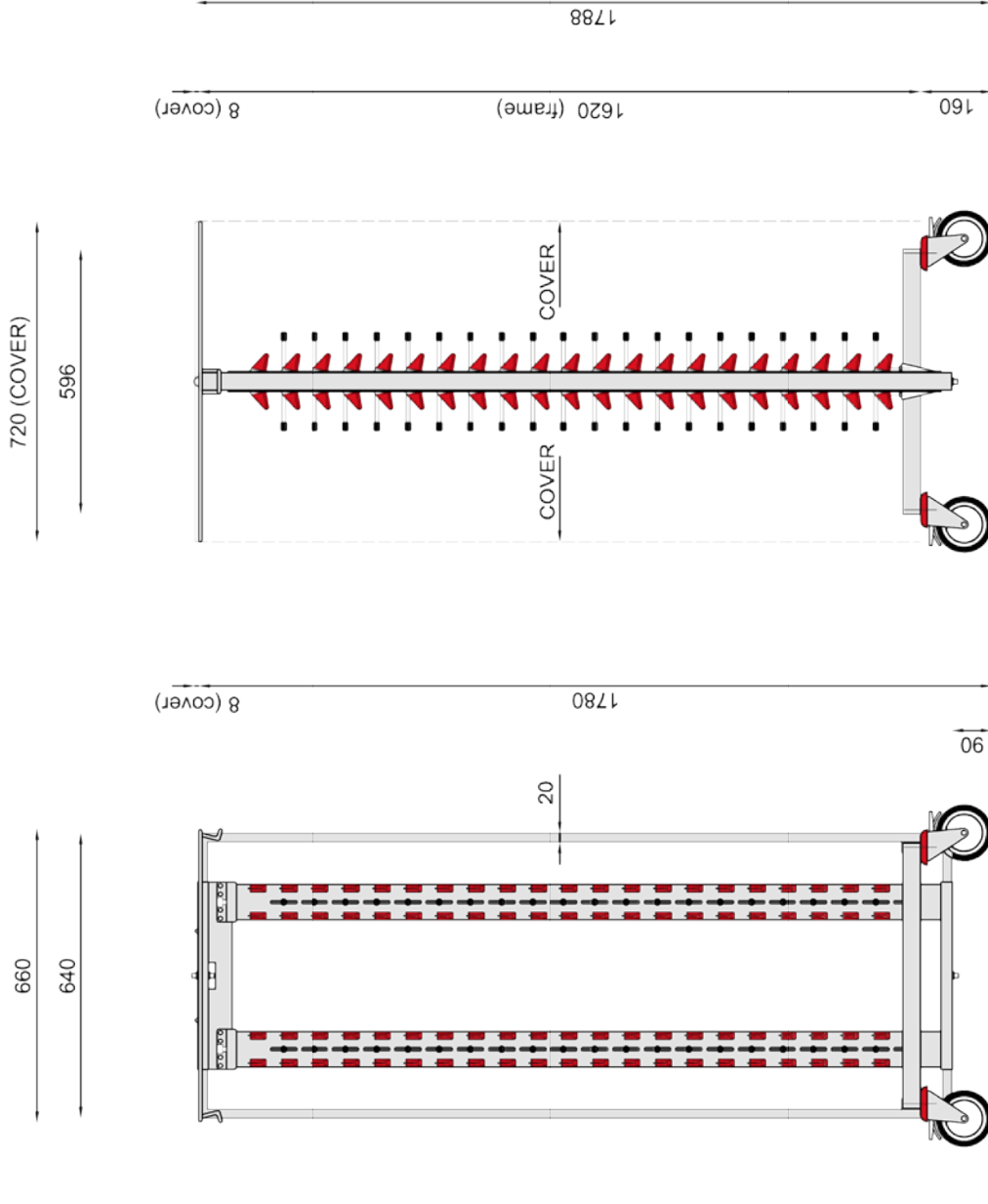

SECTION

LEFT / RIGHTSIDE

FRONT

PM 84 HEAVY DUTY CODE 484



WM12

DESIGNLINE



CODE

401 404 407
402 405 408
403 406 409

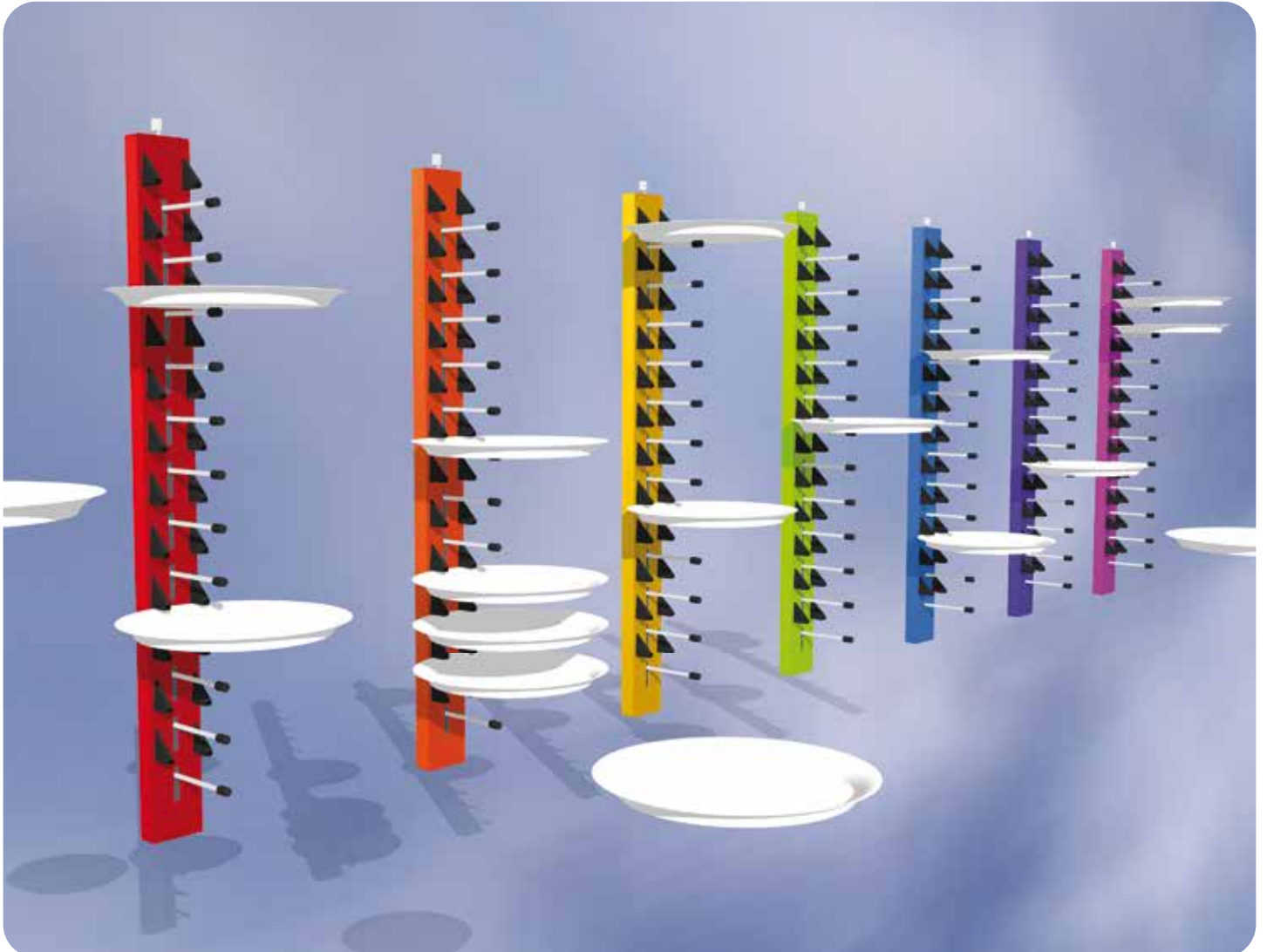
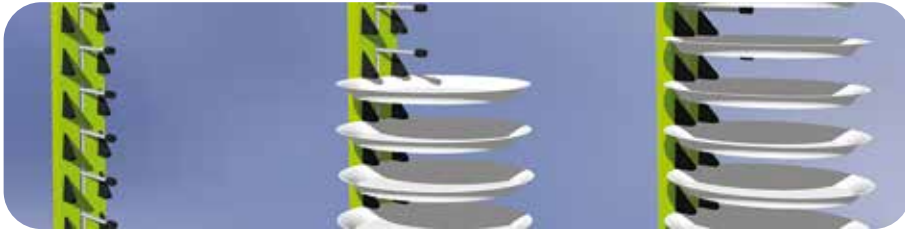

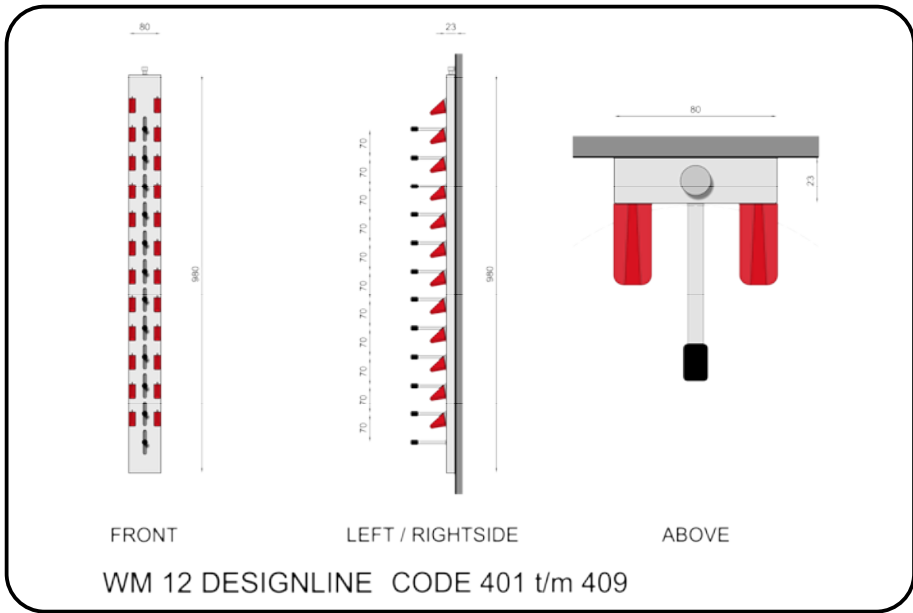

WALL MODEL: DESIGNLINE

CAPACITY: 12 PLATES

100 % STAINLESS STEEL : (401)
 COLOR: RED (402)
 WHITE (403)
 BLACK (404)
 NANO RED (405)
 NANO ORANGE (406)
 NANO YELLOW (407)
 NANO GREEN (408)
 NANO BLUE (409)

TOTAL HEIGHT: 980 mm

SIZE: 980 mm x 80 mm x 23 mm

TOTAL WEIGHT: 5 kg

TARRA: 0,7 kg

SIZE BOX: 1010 mm x 135 mm x 105 mm

WM DESIGNLINE CODE 401 t/m 409

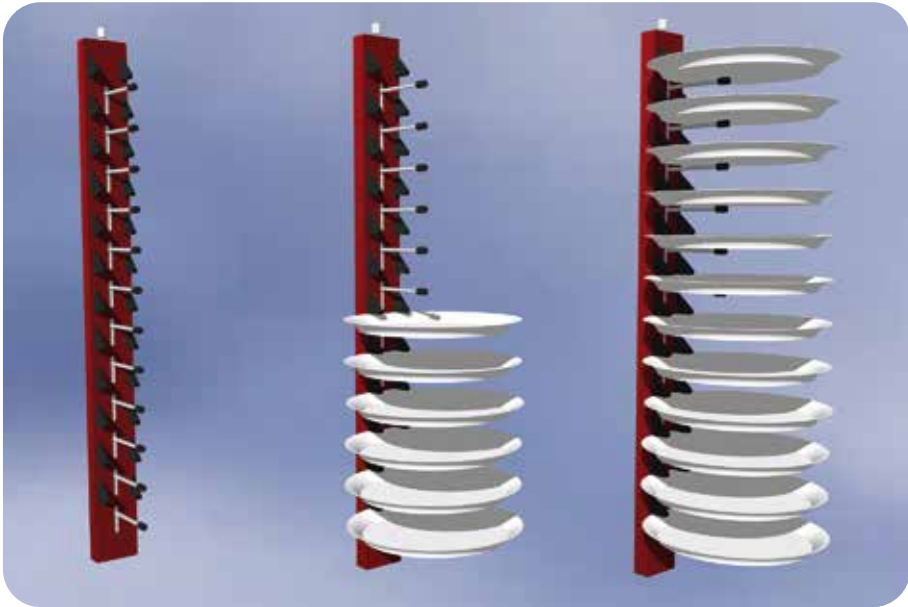

80

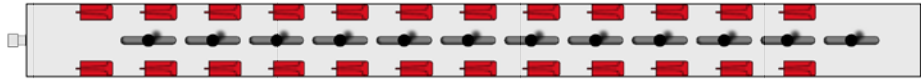

086

23

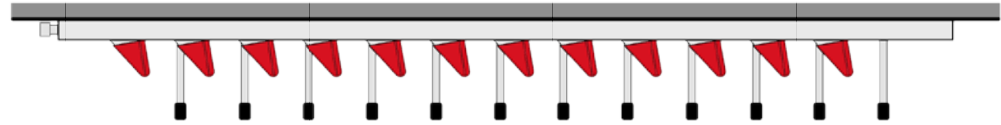

086

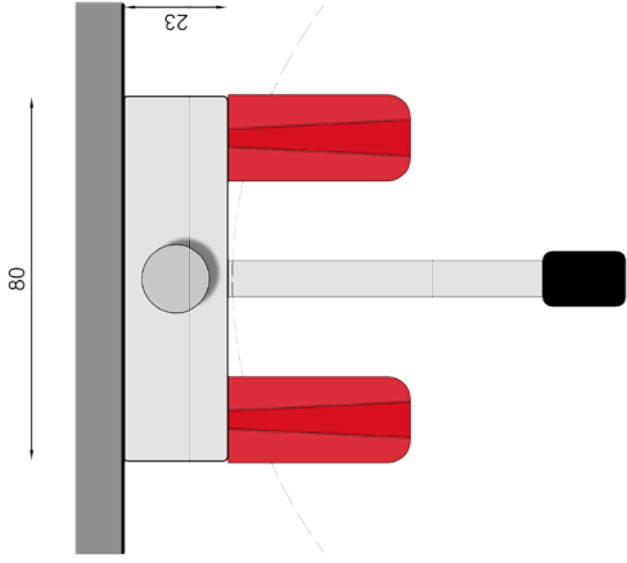

FRONT

LEFT / RIGHTSIDE

ABOVE

WM 12 DESIGNLINE CODE 401 t/m 409



WM14

BOTTLE HOLDER

STAINLESS STEEL
WHITE



CODE
414 415

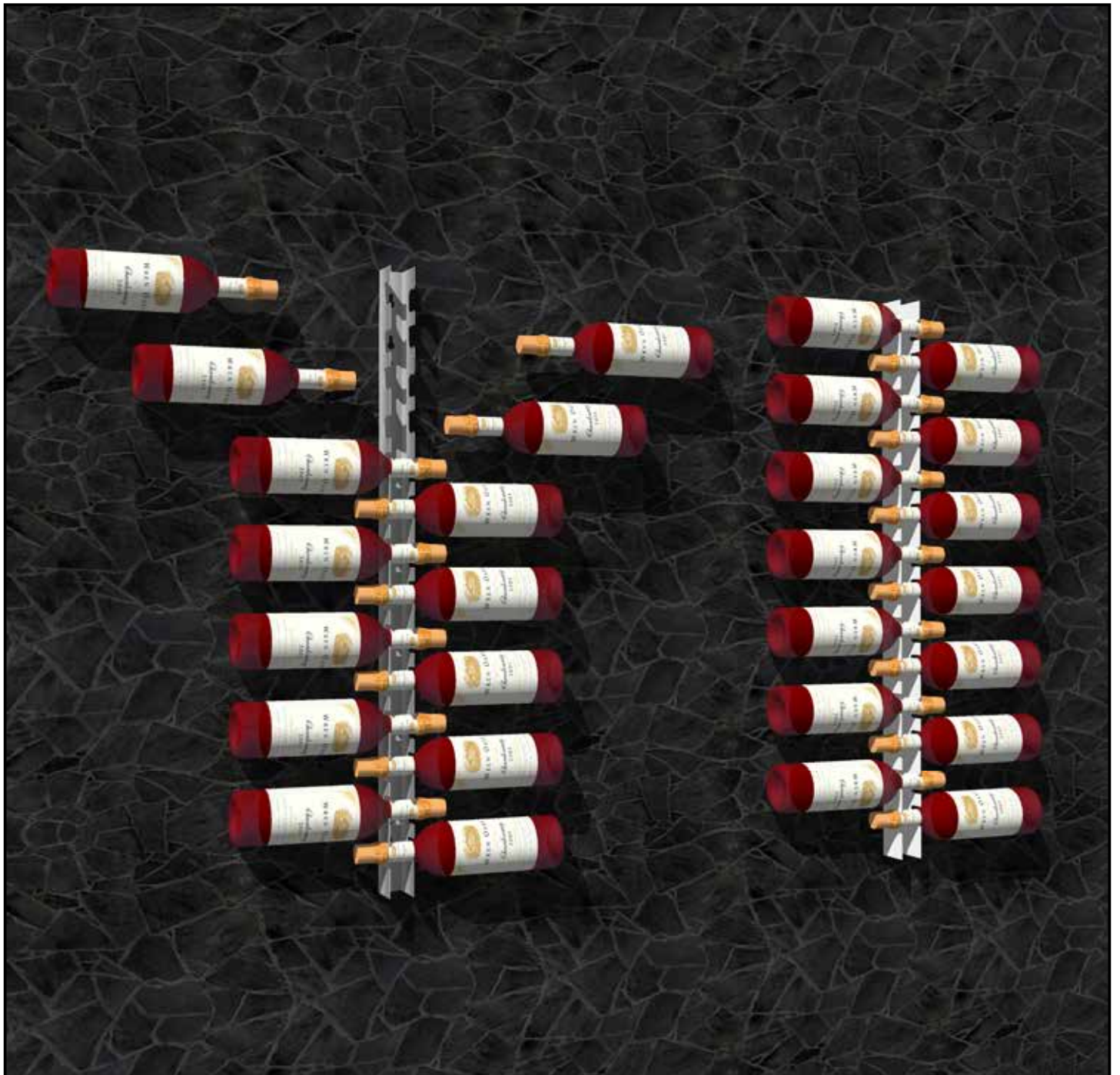

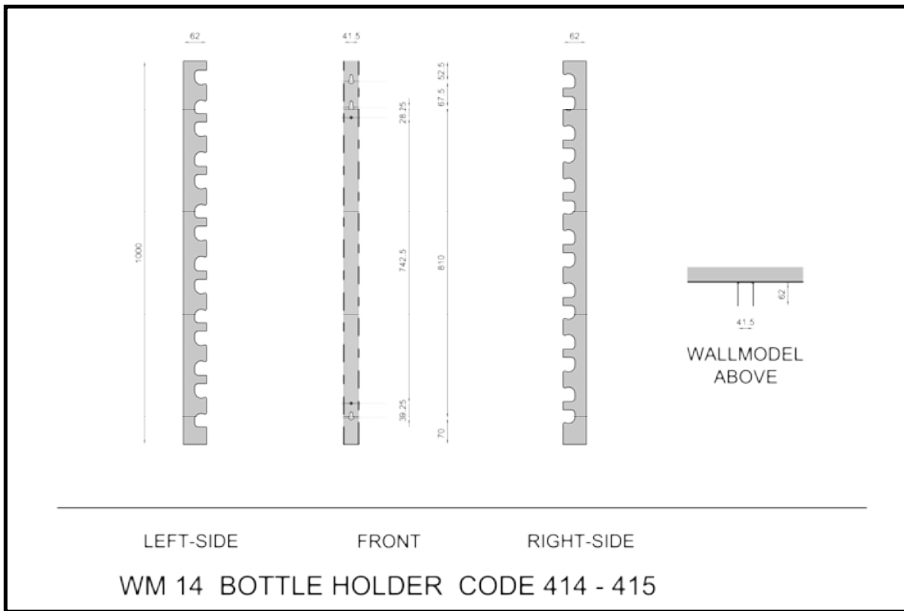

CAPACITY:
(2 X 7) = 14 BOTTLES

TOTAL HEIGHT:
1000 mm

SIZE WALLMODEL:
41.5 x 62 x 1000 mm

MATERIAL:
100 % STAINLESS STEEL,
NATURAL or COATED WHITE

TOTAL WEIGHT:
1 kg

TARRA:
0,3 kg

SIZE BOX:
101 x 8 x 8 cm

WM 14 BOTTLE HOLDER CODE 414 - 415

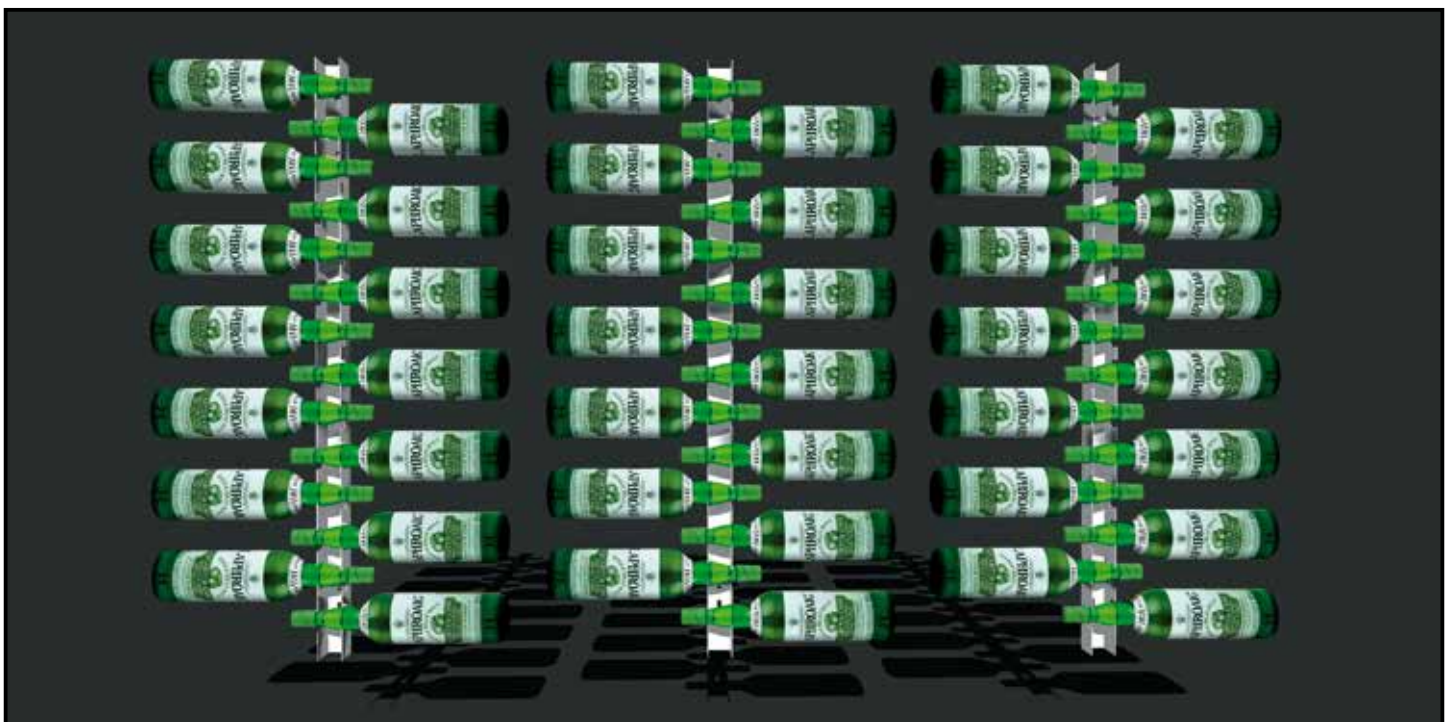

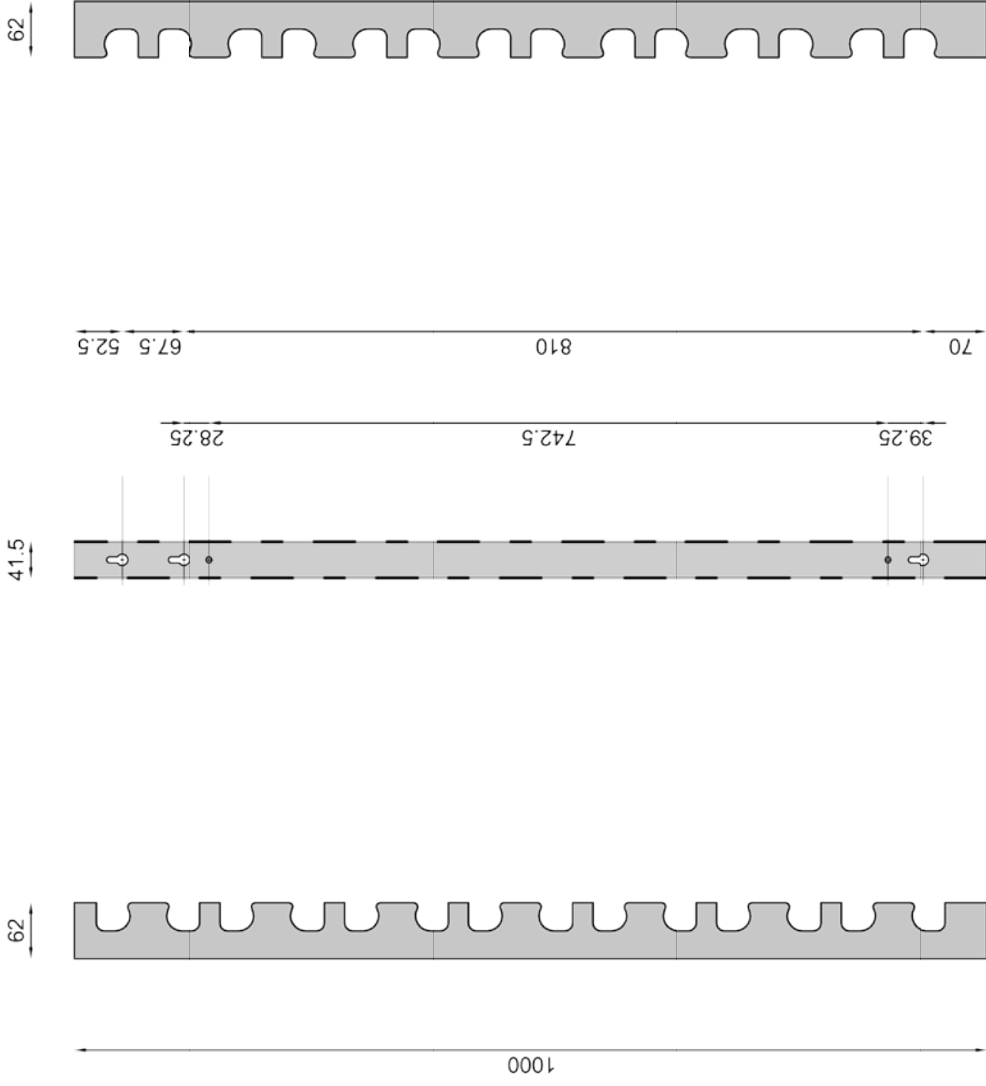

LEFT-SIDE FRONT RIGHT-SIDE

WM 14 BOTTLE HOLDER CODE 414 - 415



ST14

BOTTLE HOLDER STANDARD

STAINLESS STEEL
WHITE



CODE
424 425

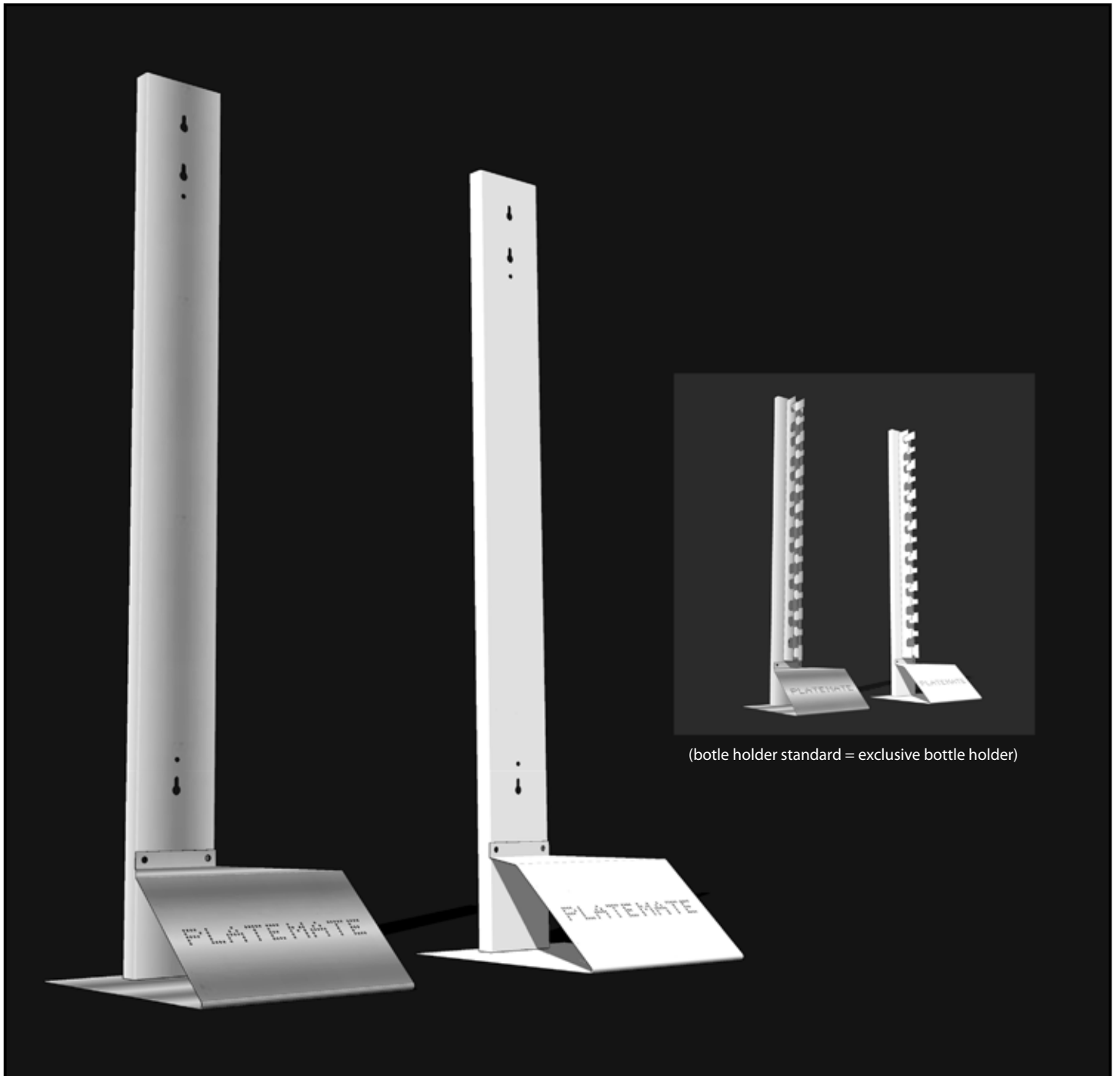

(bottle holder standard = exclusive bottle holder)

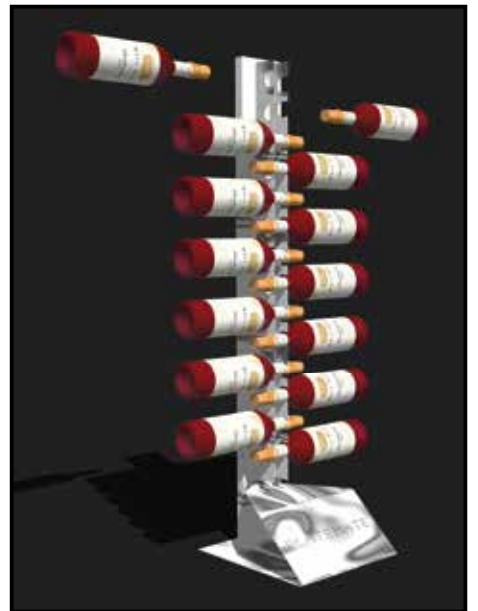
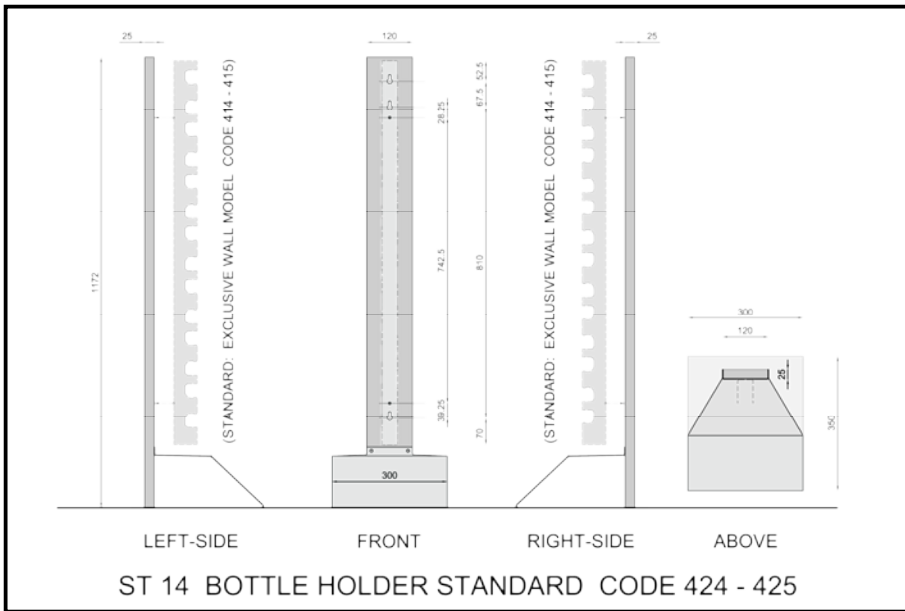

CAPACITY:
(2 X 7) = 14 BOTTLES

TOTAL HEIGHT STANDARD:
1172 mm

SIZE WALLMODEL:
41.5 x 62 x 1000 mm

MATERIAL:
100 % STAINLESS STEEL,
NATURAL or COATED WHITE

TOTAL WEIGHT:
kg

TARRA:
kg

SIZE BOX:
x x cm

ST 14 BOTTLE STANDARD HOLDER CODE 424-425

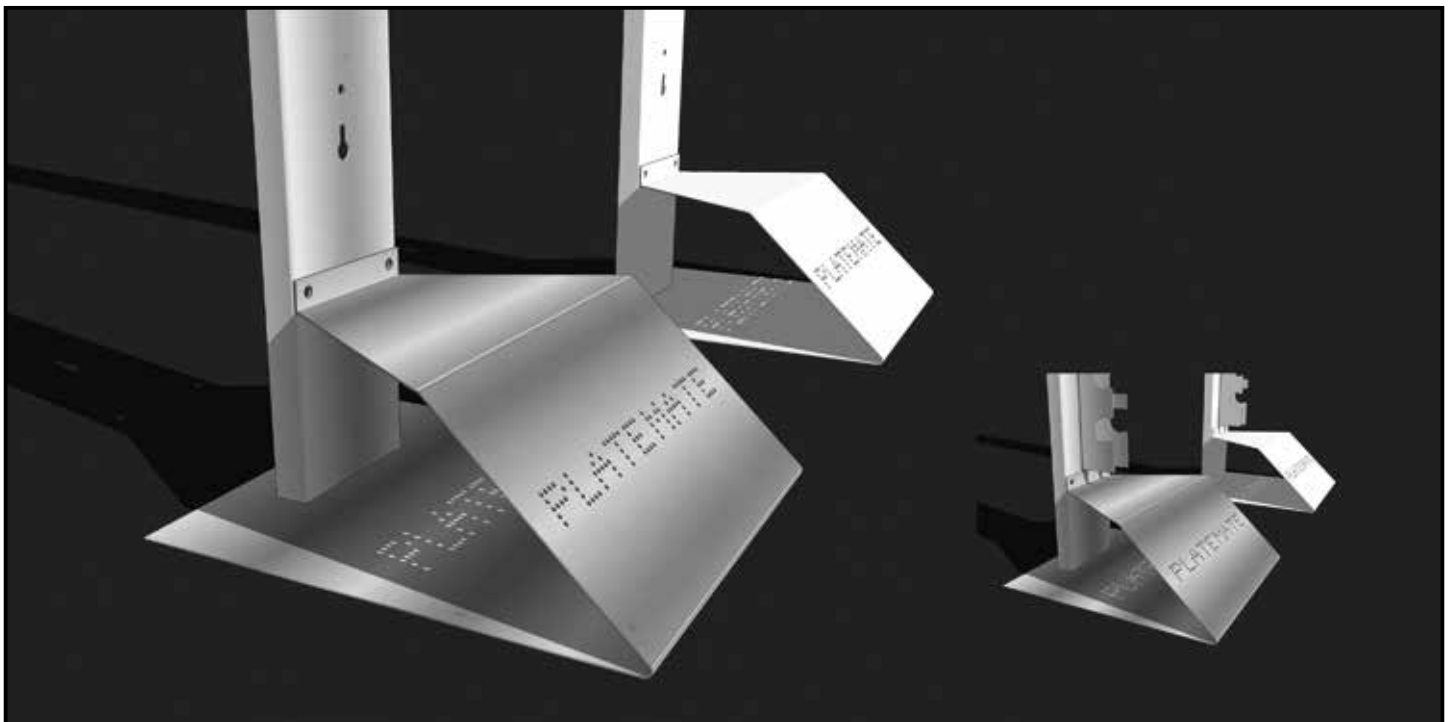
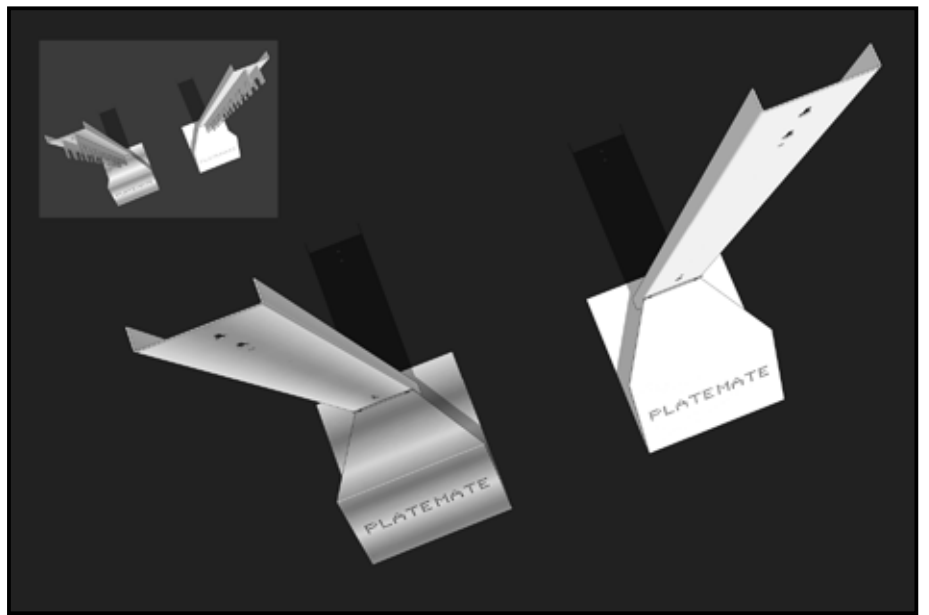

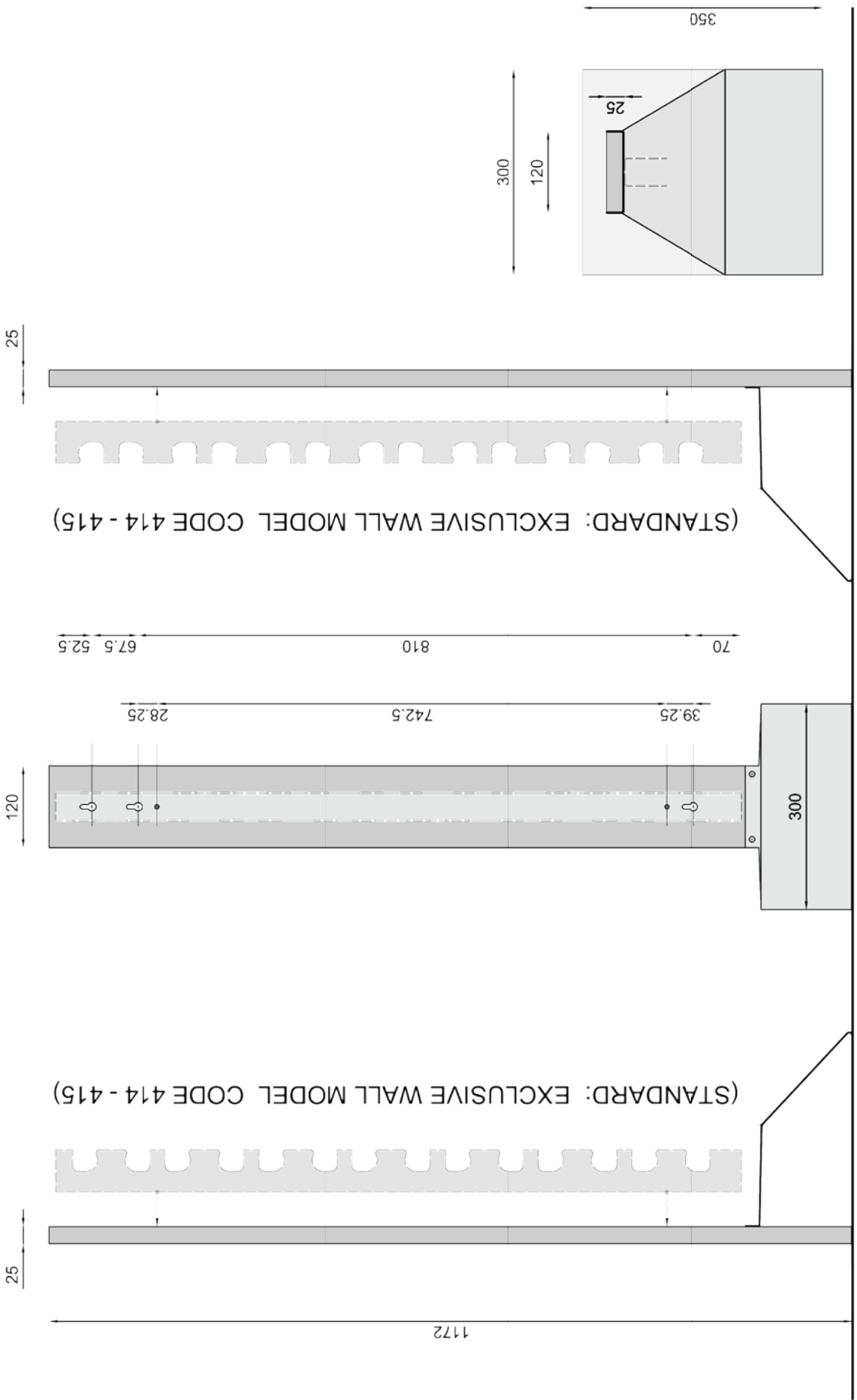

ABOVE

RIGHT-SIDE

FRONT

LEFT-SIDE

ST 14 BOTTLE HOLDER STANDARD CODE 424 - 425

Table of contents

Existing models

PM 84	STANDAARD	CODE 125
PM 48	COLLAPSIBLE	CODE 155
PM 60	COLLAPSIBLE	CODE 145
PM 78	COLLAPSIBLE	CODE 140
PM 84	COLLAPSIBLE	CODE 135
PM 96	TWIN MODEL	CODE 160
PM 120	TWIN MODEL	CODE 170
PM 168	TWIN MODEL	CODE 180
TM 12	TABLE MODEL	CODE 230
TM 24	TABLE MODEL	CODE 220
TM 36	TABLE MODEL	CODE 210
TM 48	TABLE MODEL	CODE 200
WM 6	WALL MODEL	CODE 370
WM 9	WALL MODEL	CODE 360
WM 12	WALL MODEL	CODE 350
WM 18	WALL MODEL	CODE 340
WM 21	WALL MODEL	CODE 330
WM 48	WALL MODEL	CODE 300
STANDARD COVER	STANDARD - COLLAPSIBLE - TWIN - IKE - HEAVY DUTY	
THERMO COVER	STANDARD - COLLAPSIBLE	
PLATEMATE CLIP	CODE 010	

The Plate Mate Catalogue





PM 84 STANDAARD



CODE
125

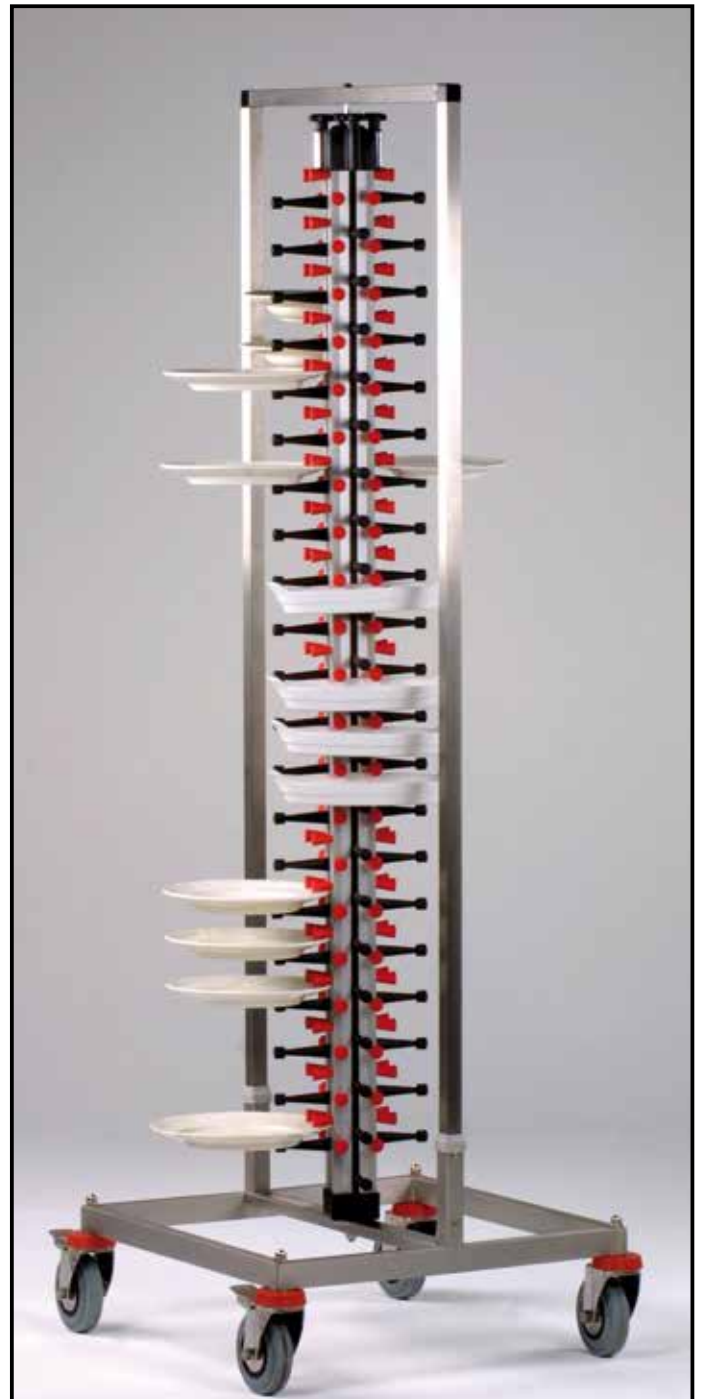



CAPACITY:
(4 X 21) = 84 PLATES

TOTAL HEIGHT:
185 cm

FRAME: 100 % STAINLESS STEEL

SIZE FRAME UNDERCARRIAGE:
60 x 60 cm

WHEELSIZE:
125 mm

NETTO WEIGHT:
23 kg

TARRA WEIGHT:
2 kg

SIZE BOX FRAME:
60 x 60 x 19 cm

SIZE BOX COLUMN:
19 x 19 x 175 cm

PM 84 STANDARD CODE 125

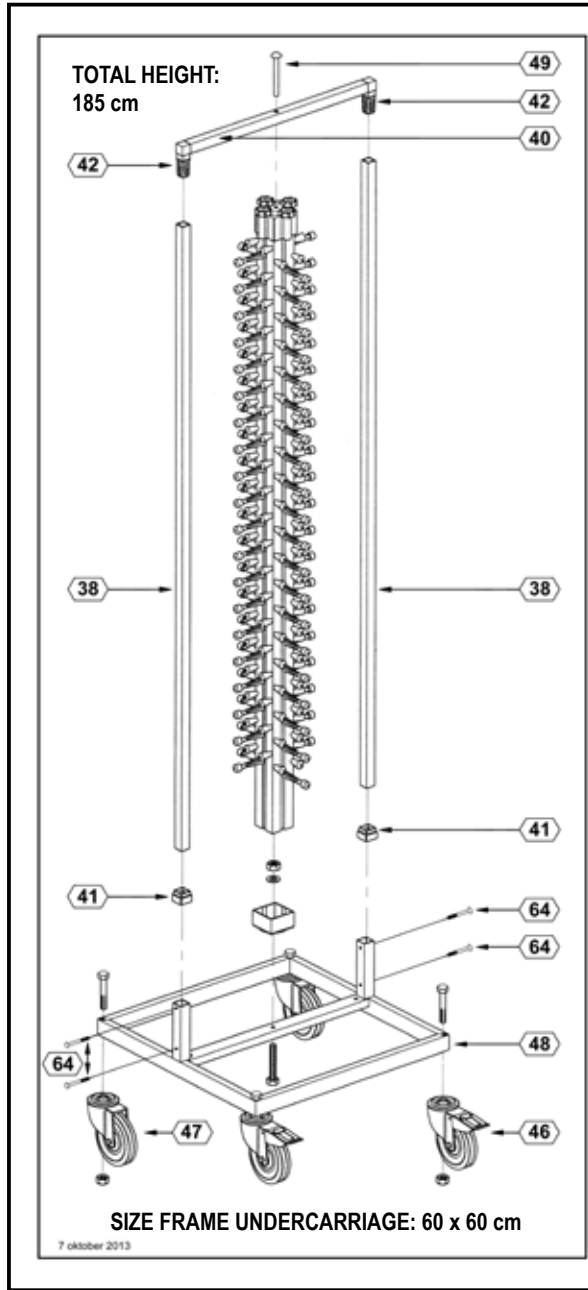

CODE 125
PM 84 STANDARD

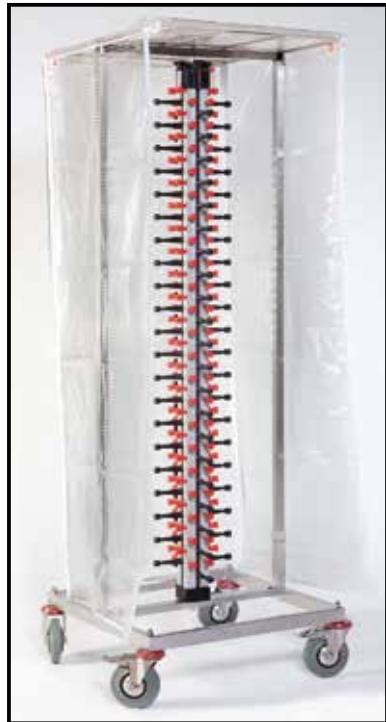

PM⁴⁸₆₀ PM⁷⁸₈₄ COLLAPSIBLE



CODE
155 140
145 135

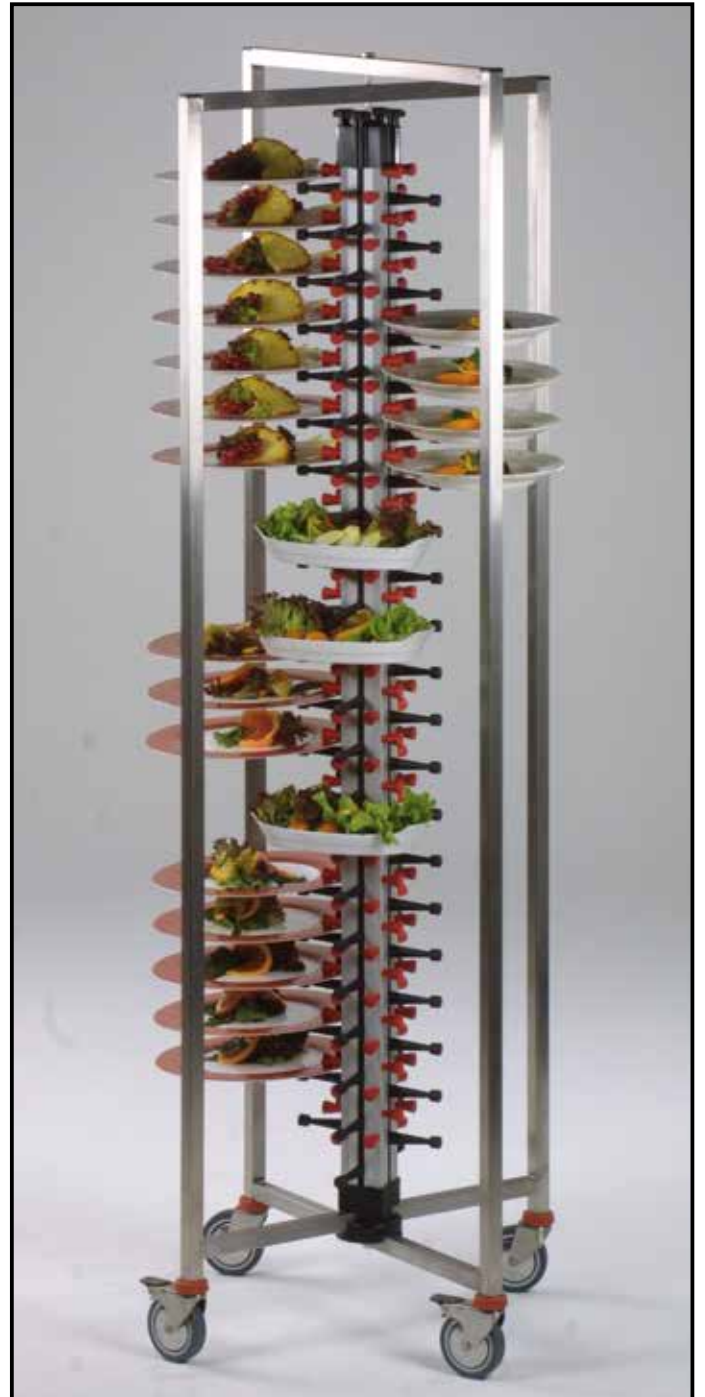
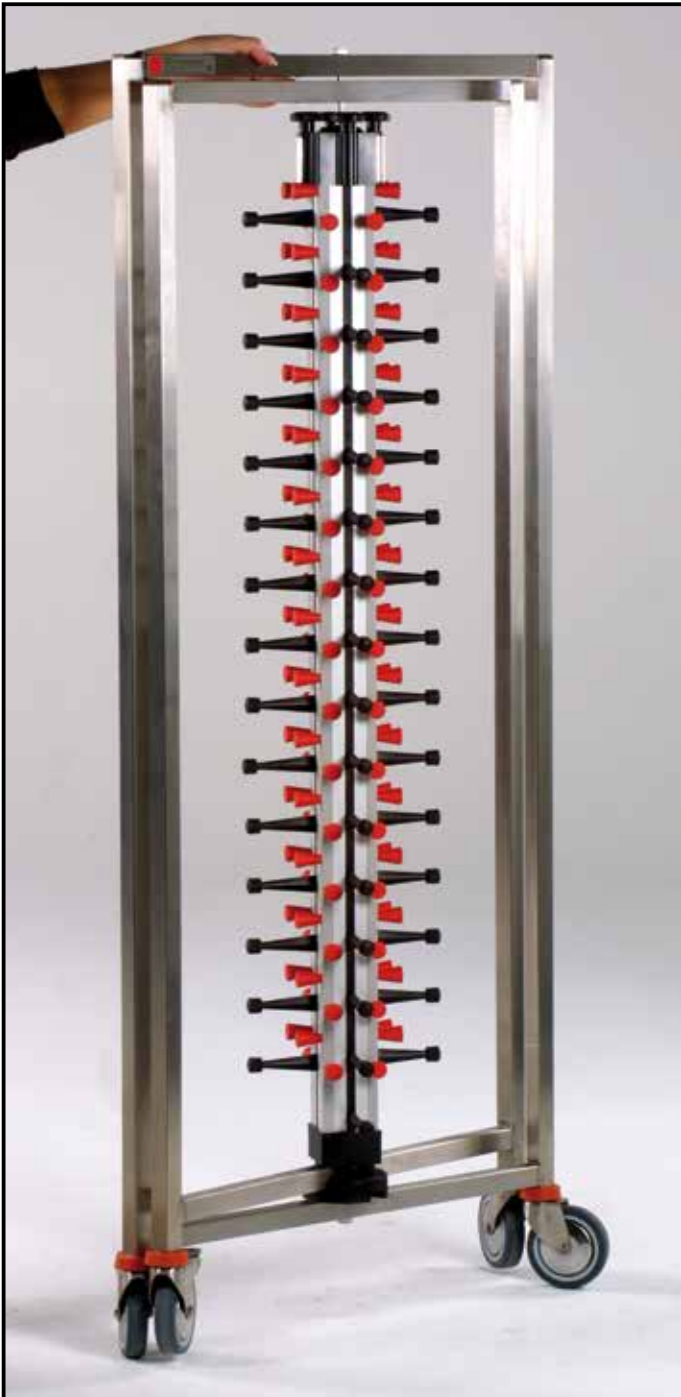
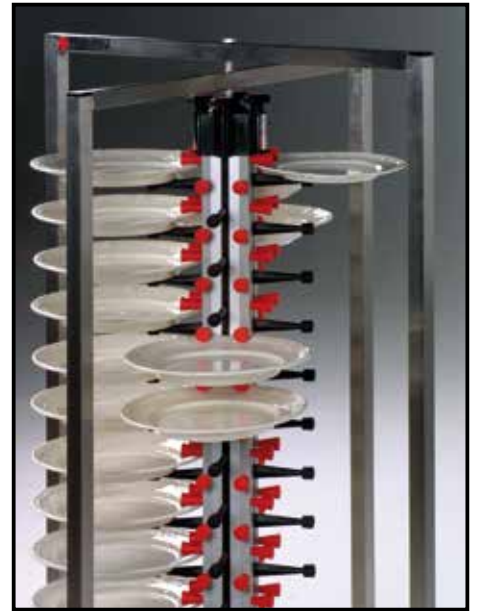

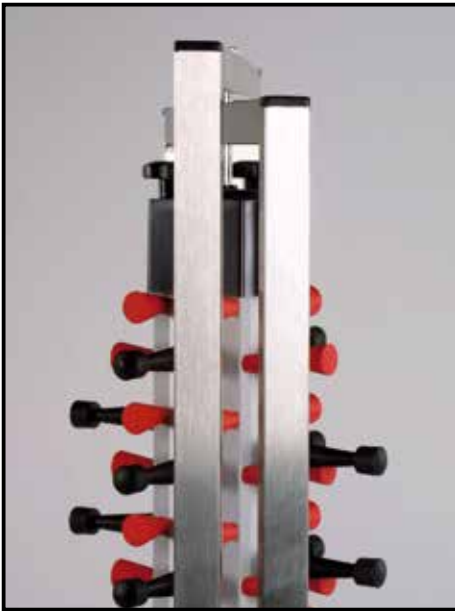

CAPACITY:

PM 48 COLL.: 48 PLATES CODE 155
 PM 60 COLL.: 60 PLATES CODE 145
 PM 78 COLL.: 78 PLATES CODE 140
 PM 84 COLL.: 84 PLATES CODE 135

TOTAL HEIGHT: **NETTO/TARRA WEIGHT:**

PM 48: 127 cm 14,5 kg / 1,5 kg
 PM 60: 149 cm 17 kg / 2 kg
 PM 78: 179 cm kg / kg
 PM 84: 189 cm 21,5 kg / 2,5 kg

FRAME: 100 % STAINLESS STEEL

SIZE FRAME UNDERCARRIAGE:
 48 x 48 cm (length tubes: 65 cm)

WHEELSIZE:
 125 mm

SIZE BOXES:

PM 48: (125 x 20 x 20) (130 x 70 x 12 cm)
 PM 60: (135 x 20 x 20) (150 x 70 x 12 cm)
 PM 78: () ()
 PM 84: (180 x 75 x 20)

PM COLLAPSIBLE CODE 135 - 140 - 145 - 155

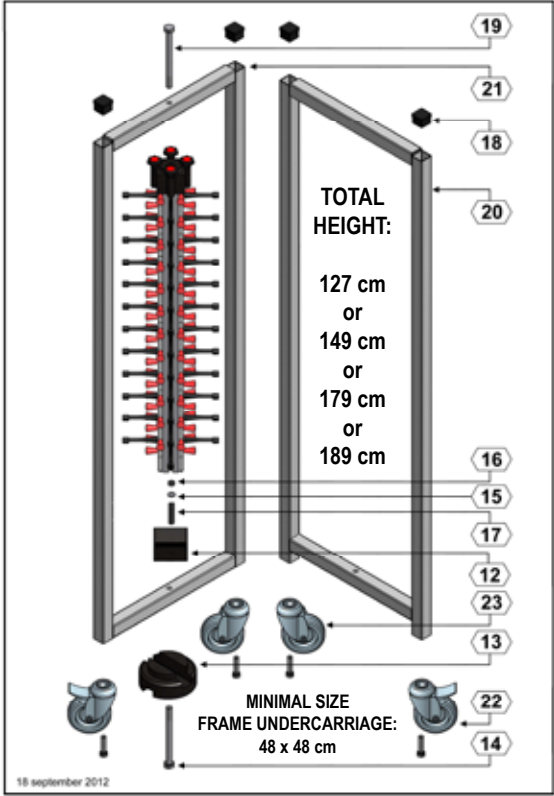

PM 48 COLL (CODE 155)
 PM 60 COLL (CODE 145)
 PM 84 COLL (CODE 135)
 PM 78 COLL (CODE 140)
PM COLLAPSIBLE

Plate mate .com



PM⁹⁶ PM¹²⁰ PM¹⁶⁸ TWIN MODELS



CODE
160 170
180





TOTAL HEIGHT:
 PM 168: 186 cm
 PM 120: 158 cm
 PM 96: 138 cm

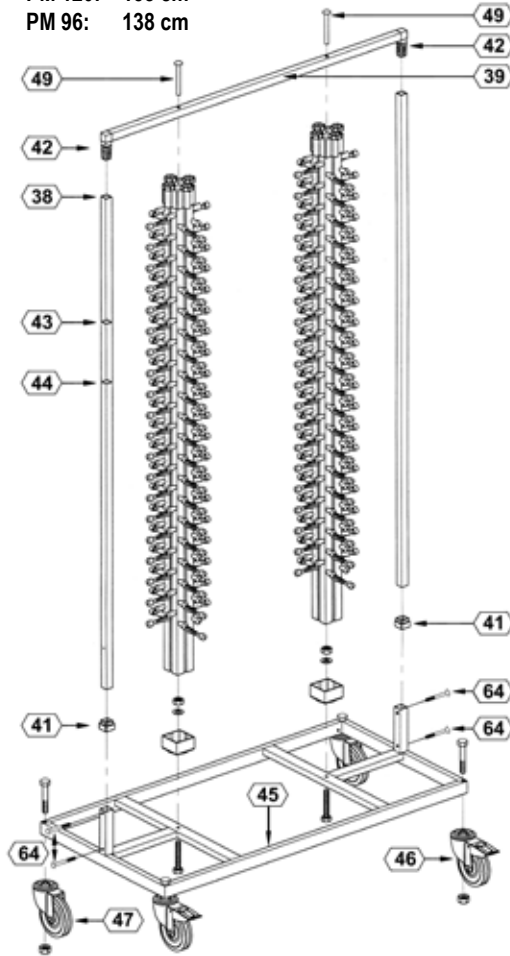

CAPACITY:

PM 96: 96 PLATES CODE 160
 PM 120: 120 PLATES CODE 170
 PM 168: 168 PLATES CODE 180

TOTAL HEIGHT: NETTO/TARRA WEIGHT:

PM 96: 138 cm 24 kg / 2 kg
 PM 120: 158 cm 25,5 kg / 2,5 kg
 PM 168: 186 cm 31,5 kg / 2,5 kg

FRAME: 100 % STAINLESS STEEL

WHEELSIZE:
 125 mm

MAX. DIAMETER PLATES: 33 cm

SIZE BOX FRAME:
 120 x 60 x 20 cm

SIZE BOX COLUMN:
 PM 96: 125 x 20 x 40 cm
 PM 120: 135 x 20 x 40 cm
 PM 168: 175 x 20 x 40 cm

TWIN MODELS CODE 160 - 170 - 180

PM TWIN 168 / CODE 180
 PM TWIN 120 / CODE 170
 PM TWIN 96 / CODE 160

PM TWIN



SIZE FRAME UNDERCARRIAGE: 60 x 120 cm

7 oktober 2013



TM¹² TM³⁶ TM²⁴ TM⁴⁸ TABLE MODELS



CODE
230 210
220 200





CAPACITY:

TM 12:	12 PLATES	CODE 230
TM 24:	24 PLATES	CODE 220
TM 36:	36 PLATES	CODE 210
TM 48:	48 PLATES	CODE 200

TOTAL HEIGHT:

TM 12:	49 cm	3 kg / 0,7 kg
TM 24:	73 cm	3,9 kg / 0,7 kg
TM 36:	93 cm	5,2 kg / 0,8 kg
TM 48:	114 cm	6,4 kg / 0,9 kg

SIZE BOX:

TM 12:	56 x 19 x 19 cm
TM 24:	75 x 20 x 20 cm
TM 36:	100 x 20 x 20 cm
TM 48:	120 x 20 x 20 cm

TABLE MODELS CODE 230 - 220 - 210 - 200

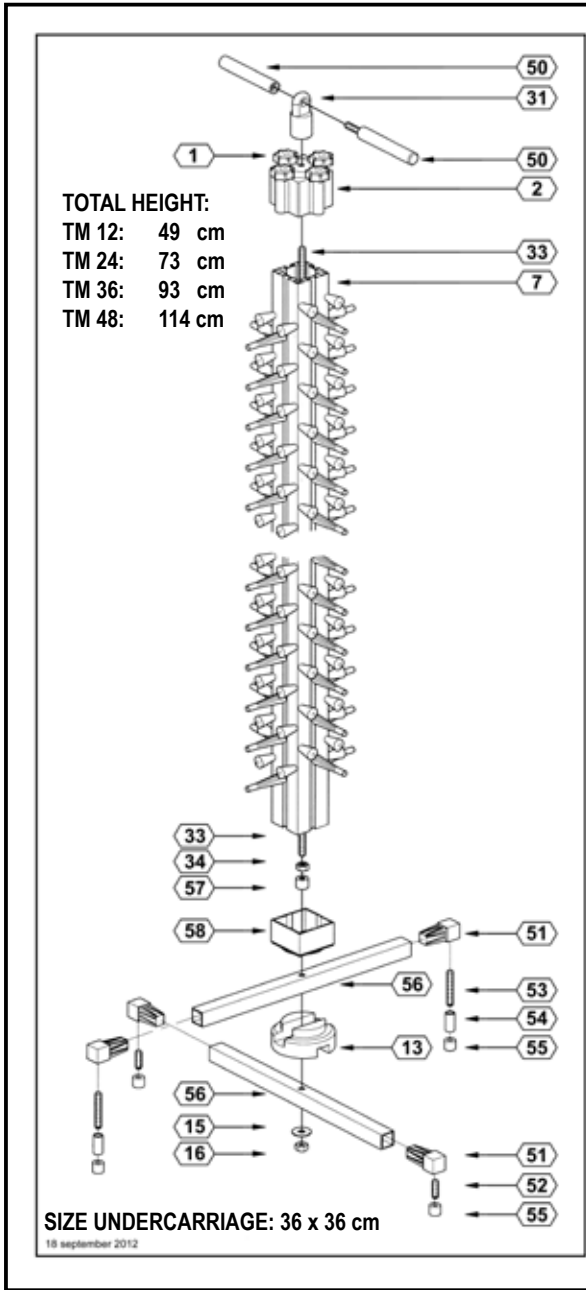

TM 12 - CODE 230
 TM 24 - CODE 220
 TM 36 - CODE 210
 TM 48 - CODE 200

TABLE MODEL



**WM 6
9**

**WM 21
48**

**WM 12
18**

CODE

370 330

360 300

350

340

**WALL
MODELS**

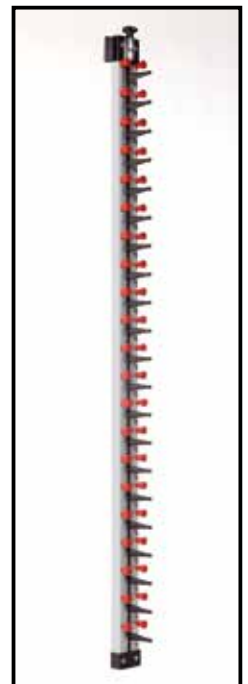
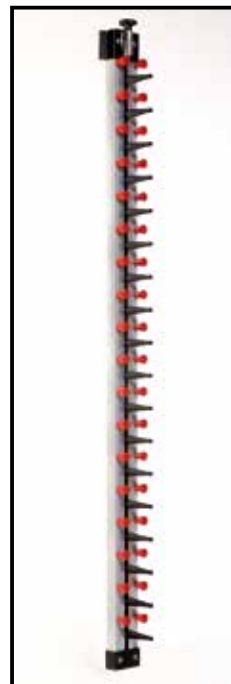
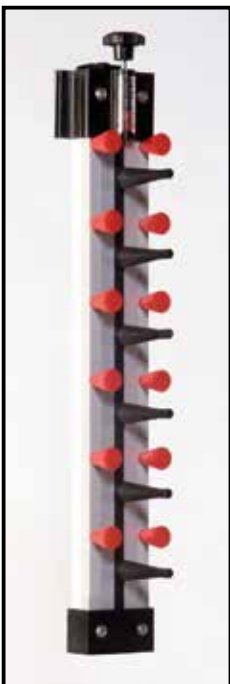
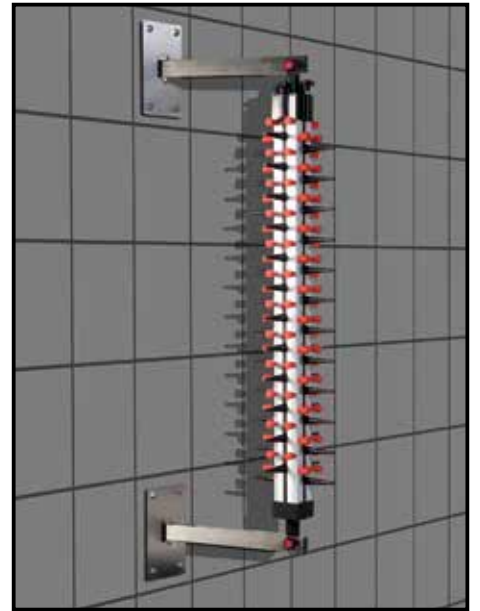



CAPACITY:		
WM 6	6 PLATES	CODE 370
WM 9	9 PLATES	CODE 360
WM 12	12 PLATES	CODE 350
WM 18	18 PLATES	CODE 340
WM 21	21 PLATES	CODE 330
WM 48	48 PLATES	CODE 300

HEIGHT:		NETTO / TARRA WEIGHT:	
WM 6	57 cm	1	/ 0,2 kg
WM 9	77 cm	1,5	/ 0,3 kg
WM 12	99 cm	1,9	/ 0,3 kg
WM 18	141 cm	2,7	/ 0,4 kg
WM 21	162 cm	3	/ 0,3 kg
WM 48	115 cm	8,5	/ 1,5 kg

SIZE BOX:	
WM 6:	62 x 13 x 13 cm
WM 9:	82 x 13 x 13 cm
WM 12:	103 x 13 x 13 cm
WM 18:	145 x 13 x 13 cm
WM 21:	166 x 13 x 13 cm
WM 48:	120 x 20 x 20 cm
(CODE 820):	43 x 24 x 7,5 cm (2x)

WALL MODELS CODE 370-360-350-340-330-300

TOTAL HEIGHT:
 57 cm
 77 cm
 99 cm
 141 cm
 162 cm

WIDTH:
 7 cm

18 september 2012

WM 6 - CODE 370
 WM 9 - CODE 360
 WM 12 - CODE 350
 WM 18 - CODE 340
 WM 21 - CODE 330

WALL MODEL

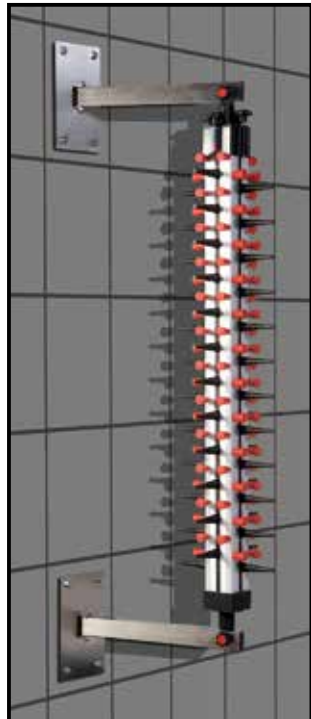

360 mm
 1330 mm
 890 mm
 125 mm

WM 48 - CODE 300
 + (2x) CODE 820 LM
WALL MODEL

STANDARD COVER

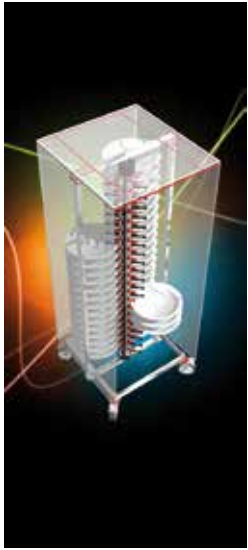

**STANDARD
COLLAPSIBLE
TWIN - IKE
HEAVY DUTY**

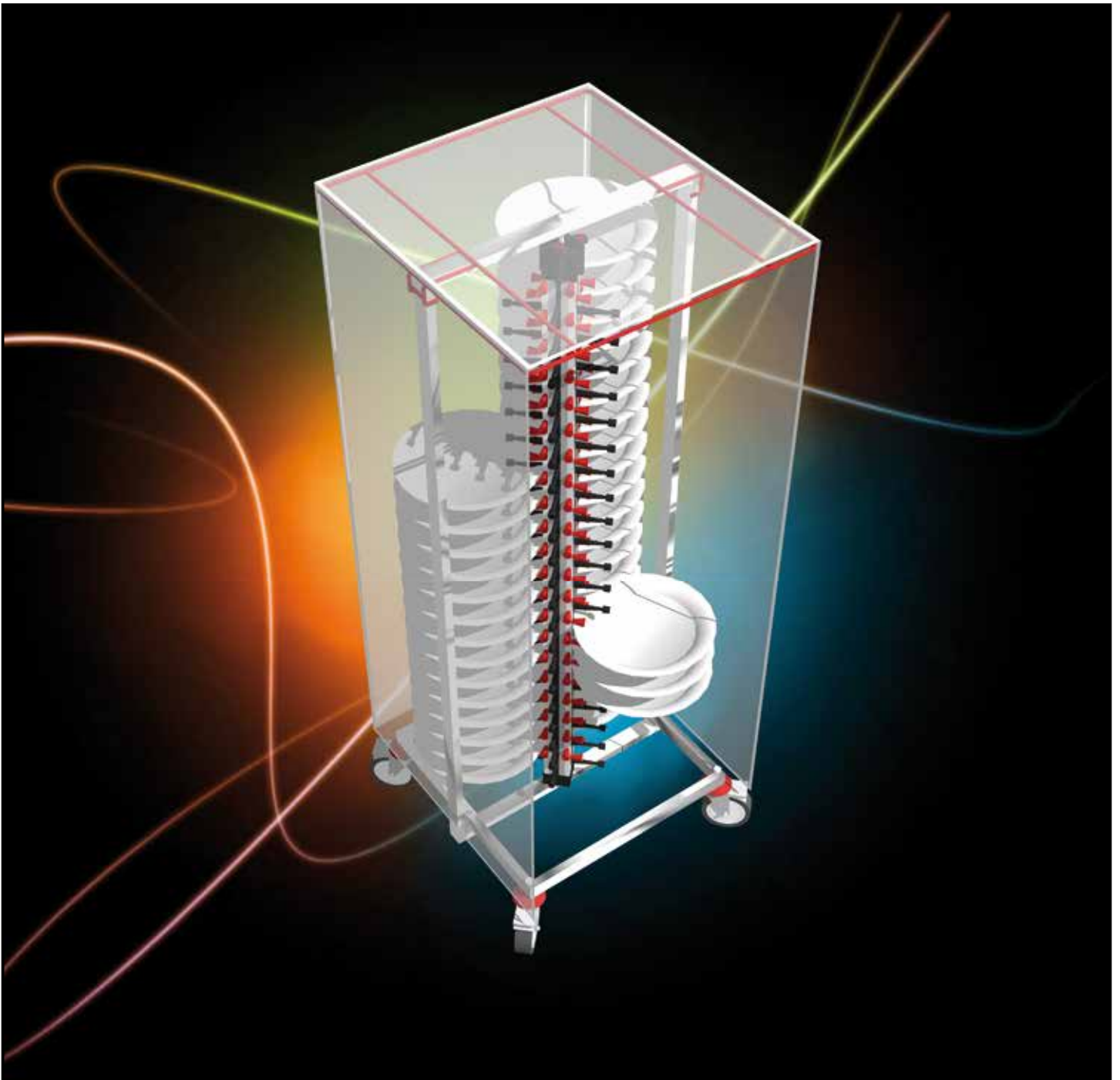
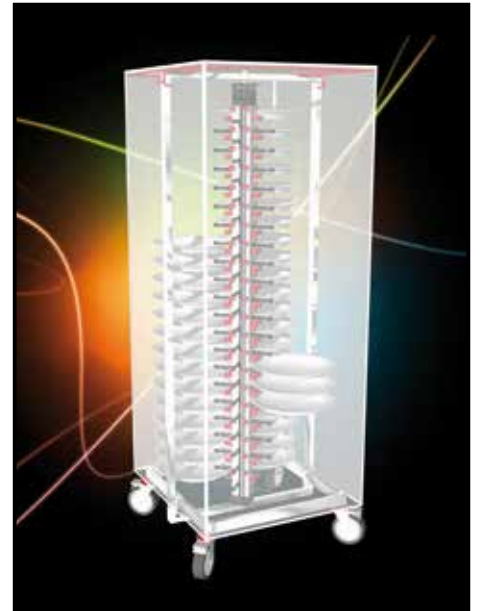

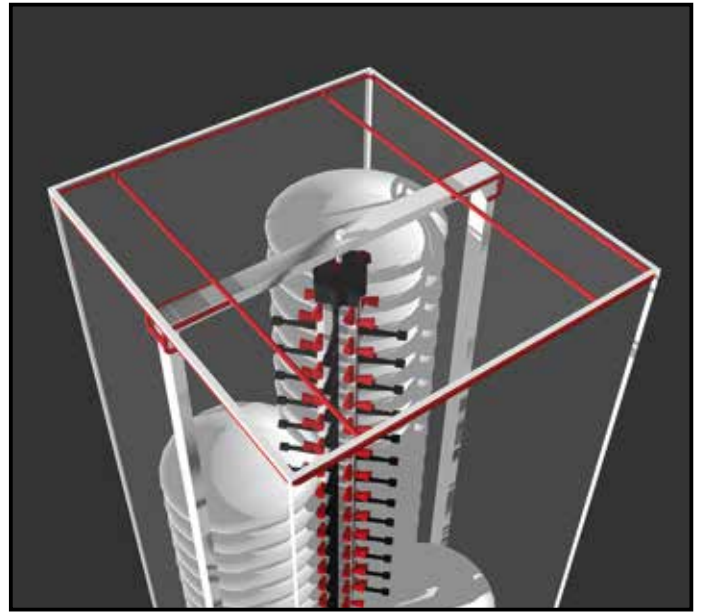
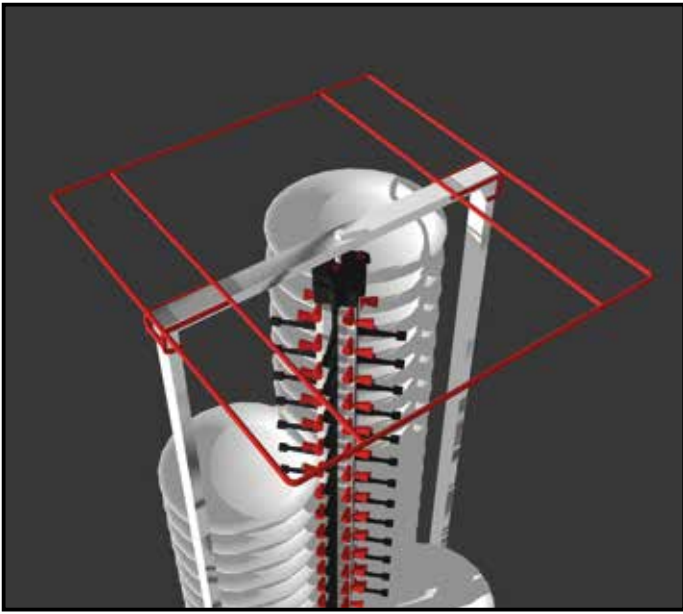

MODELS:	NETTO WEIGHT:	TARRA:
PM 84 STANDARD	3 kg	0,5 kg
PM 84 COLLAPSIBLE	3,5 kg	0,5 kg
PM 60 COLLAPSIBLE	3 kg	0,5
PM 40 COLLAPSIBLE	2,5 kg	0,5 kg
PM 168 TWIN	5,5 kg	2 kg
PM 120 TWIN	5 kg	2 kg
PM 96 TWIN	4,5 kg	2 kg
PM 84 STANDAARD IKE	3,5 kg	0,5 kg
PM 84 FLEX IKE	3,5 kg	0,5 kg
PM 84 HEAVY DUTY	3,5 kg	0,5 kg

SIZE BOX:	
PM 84 STANDARD:	65 x 65 x 5 cm
PM COLLAPSIBLE:	68 x 77 x 5 cm
PM TWIN 168 - 120 - 96:	120 x 60 x 20 cm

MATERIALS STANDARD COVER:
 PVC according to HACCP standards for food safety.

STANDARD COVER



THERMO COVER



**STANDARD
COLLAPSIBLE**

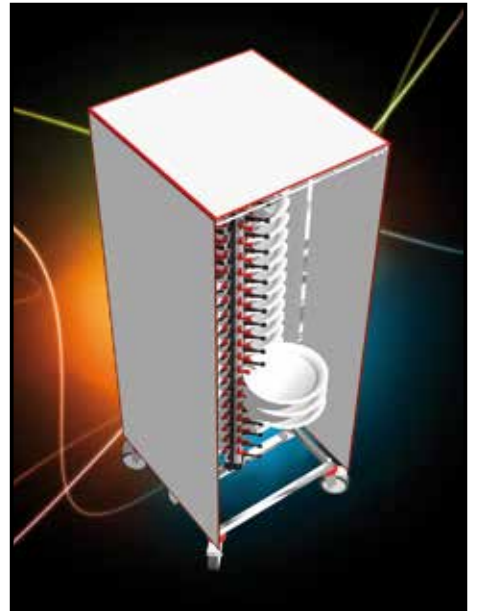

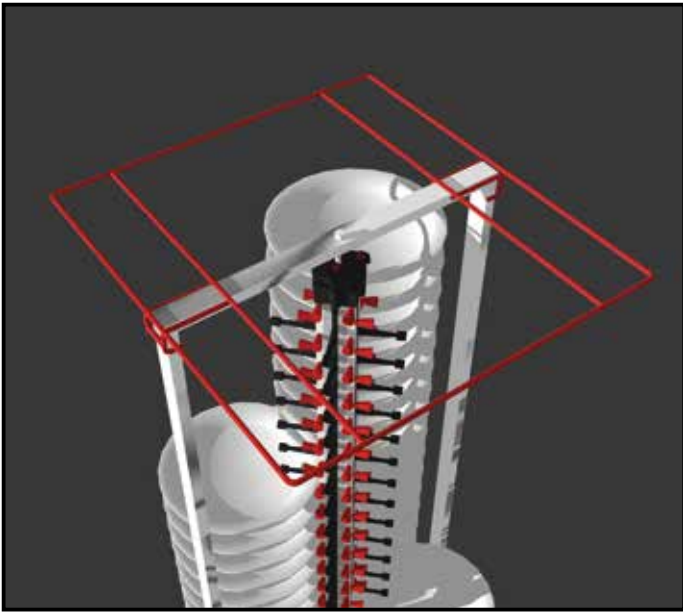

MODELS:	NETTO WEIGHT:	TARRA:
PM 84 STANDARD	3 kg	0,5 kg
PM 84 COLLAPSIBLE	3,5 kg	0,5 kg
PM 60 COLLAPSIBLE	3 kg	0,5
PM 40 COLLAPSIBLE	2,5 kg	0,5 kg
PM 168 TWIN	5,5 kg	2 kg
PM 120 TWIN	5 kg	2 kg
PM 96 TWIN	4,5 kg	2 kg
PM 84 STANDAARD IKE	3,5 kg	0,5 kg
PM 84 FLEX IKE	3,5 kg	0,5 kg
PM 84 HEAVY DUTY	3,5 kg	0,5 kg

SIZE BOX:	
PM 84 STANDARD:	65 x 65 x 5 cm
PM COLLAPSIBLE:	68 x 77 x 5 cm
PM TWIN 168 - 120 - 96:	120 x 60 x 20 cm

MATERIALS THERMO-COVER:
 PVC according to HACCP standards for food safety.

THERMO COVER

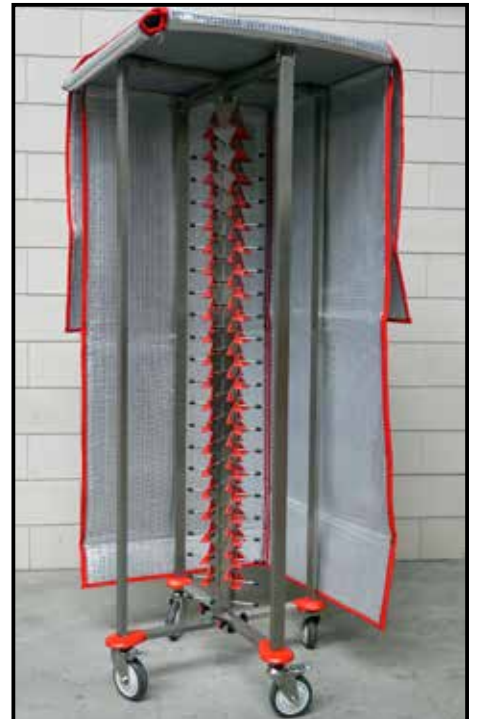
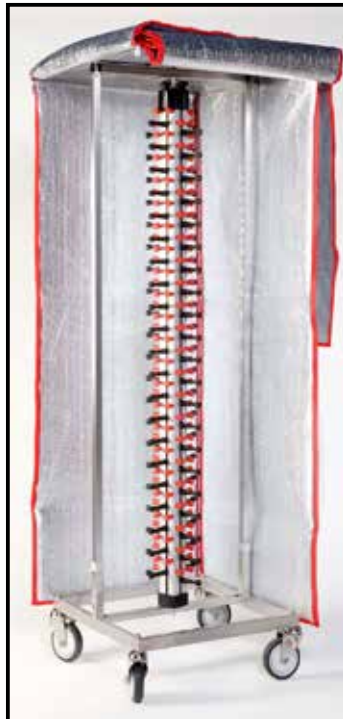



PLATEMATE CLIP



CODE
010



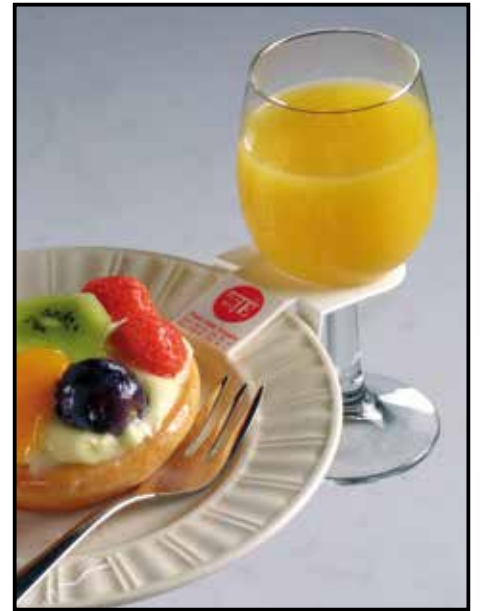

CAPACITY EACH BOX:
(4 bags x 250 clips) = 1000 clips

TOTAL WEIGHT:
9 kg

TARRA:
0,6 kg

SIZE BOX:
55 x 40 x 30 cm

PLATEMATE CLIP CODE 010



Table of contents

User manuals

PM 84	STANDAARD	CODE 125
PM 48	COLLAPSIBLE	CODE 155
PM 60	COLLAPSIBLE	CODE 145
PM 78	COLLAPSIBLE	CODE 140
PM 84	COLLAPSIBLE	CODE 135
PM 96	TWIN MODEL	CODE 160
PM 120	TWIN MODEL	CODE 170
PM 168	TWIN MODEL	CODE 180
TM 12	TABLE MODEL	CODE 230
TM 24	TABLE MODEL	CODE 220
TM 36	TABLE MODEL	CODE 210
TM 48	TABLE MODEL	CODE 200
WM 6	WALL MODEL	CODE 370
WM 9	WALL MODEL	CODE 360
WM 12	WALL MODEL	CODE 350
WM 18	WALL MODEL	CODE 340
WM 21	WALL MODEL	CODE 330
WM 48	WALL MODEL	CODE 300
PART LIST	ALL MODELS	

The Plate Mate Catalogue



TOTAL HEIGHT:
185 cm

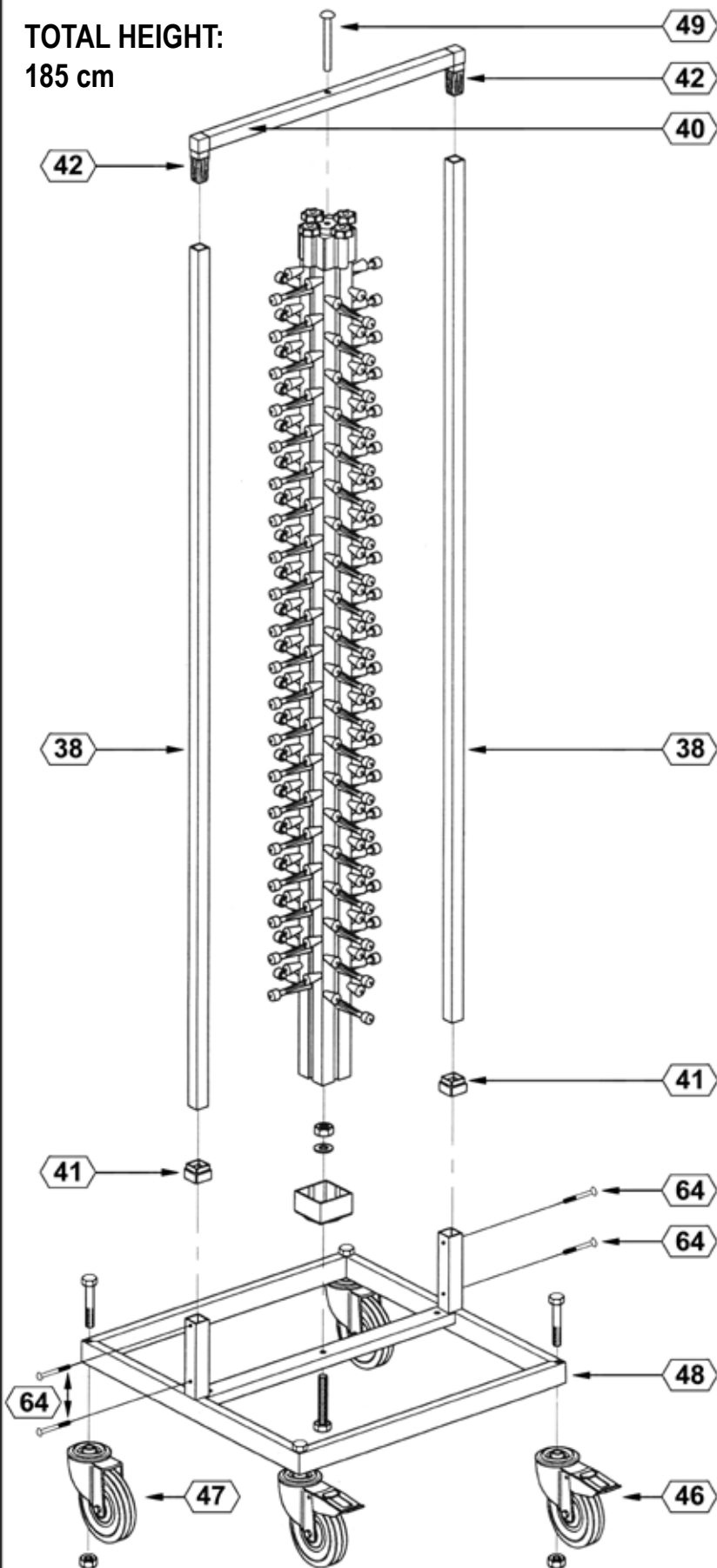

SIZE FRAME UNDERCARRIAGE: 60 x 60 cm

7 oktober 2013

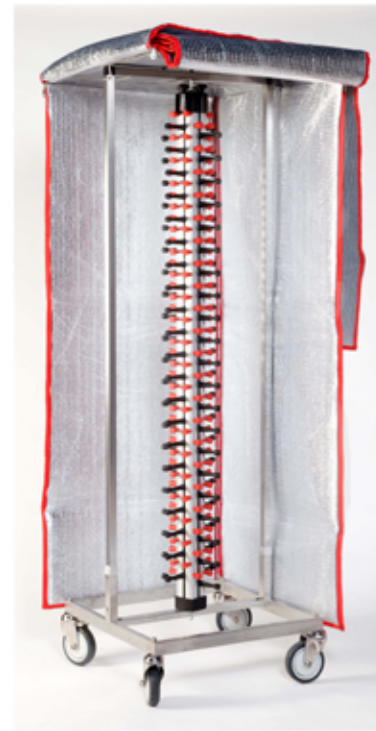

CODE 125

PM 84 STANDARD



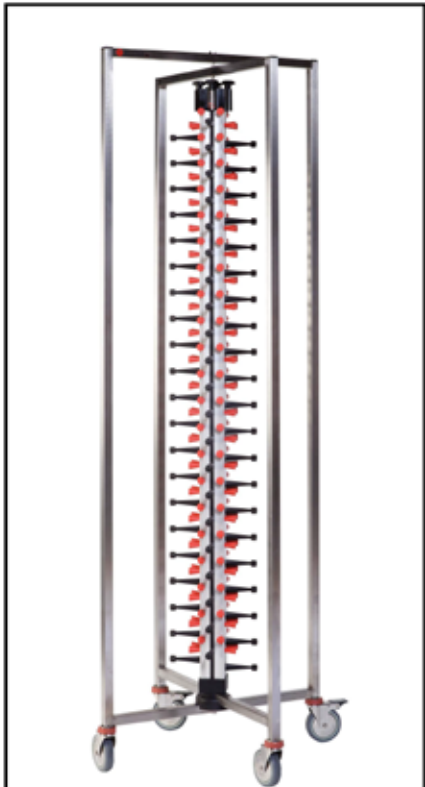
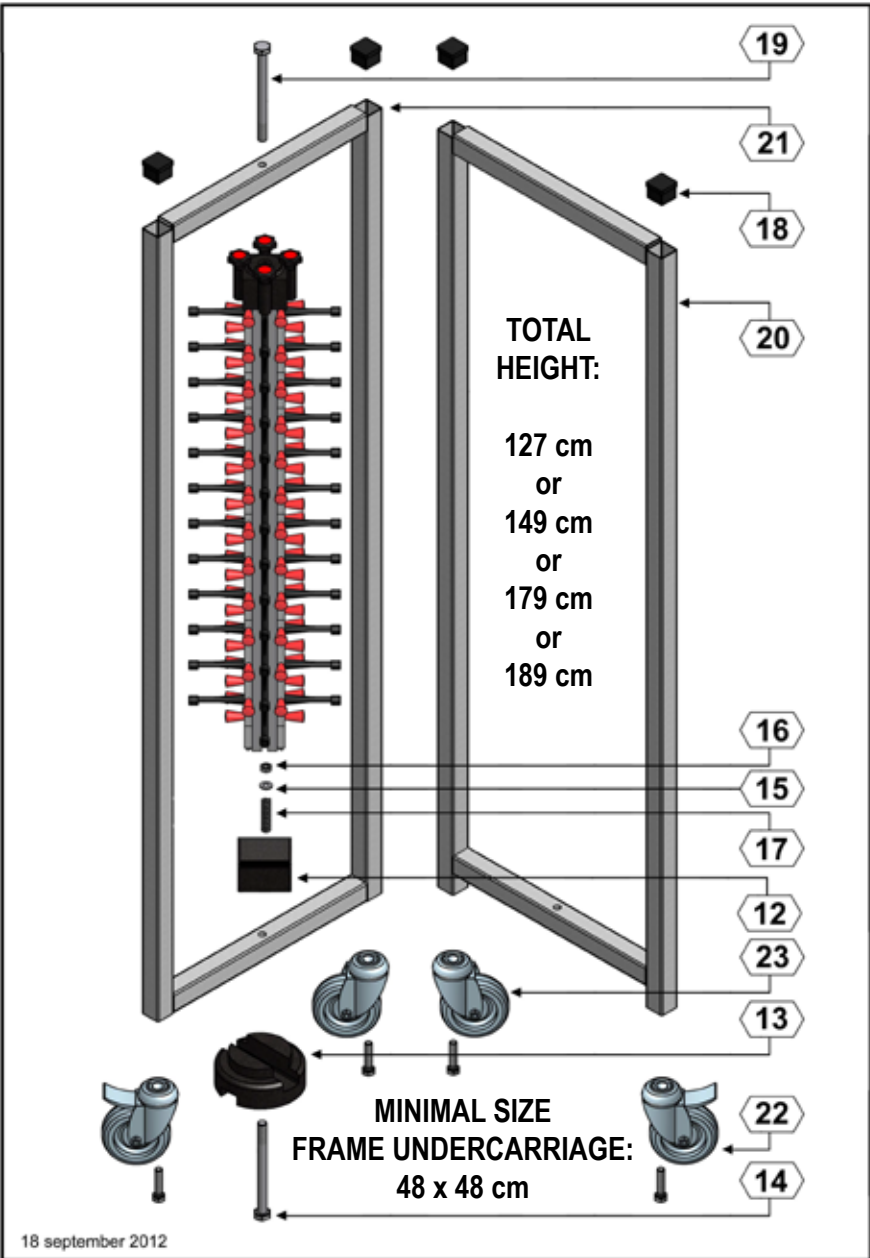

PM 48 COLL (CODE 155)
 PM 60 COLL (CODE 145)
 PM 84 COLL (CODE 135)
 PM 78 COLL (CODE 140)
PM COLLAPSIBLE



TOTAL HEIGHT:

- PM 168: 186 cm
- PM 120: 158 cm
- PM 96: 138 cm

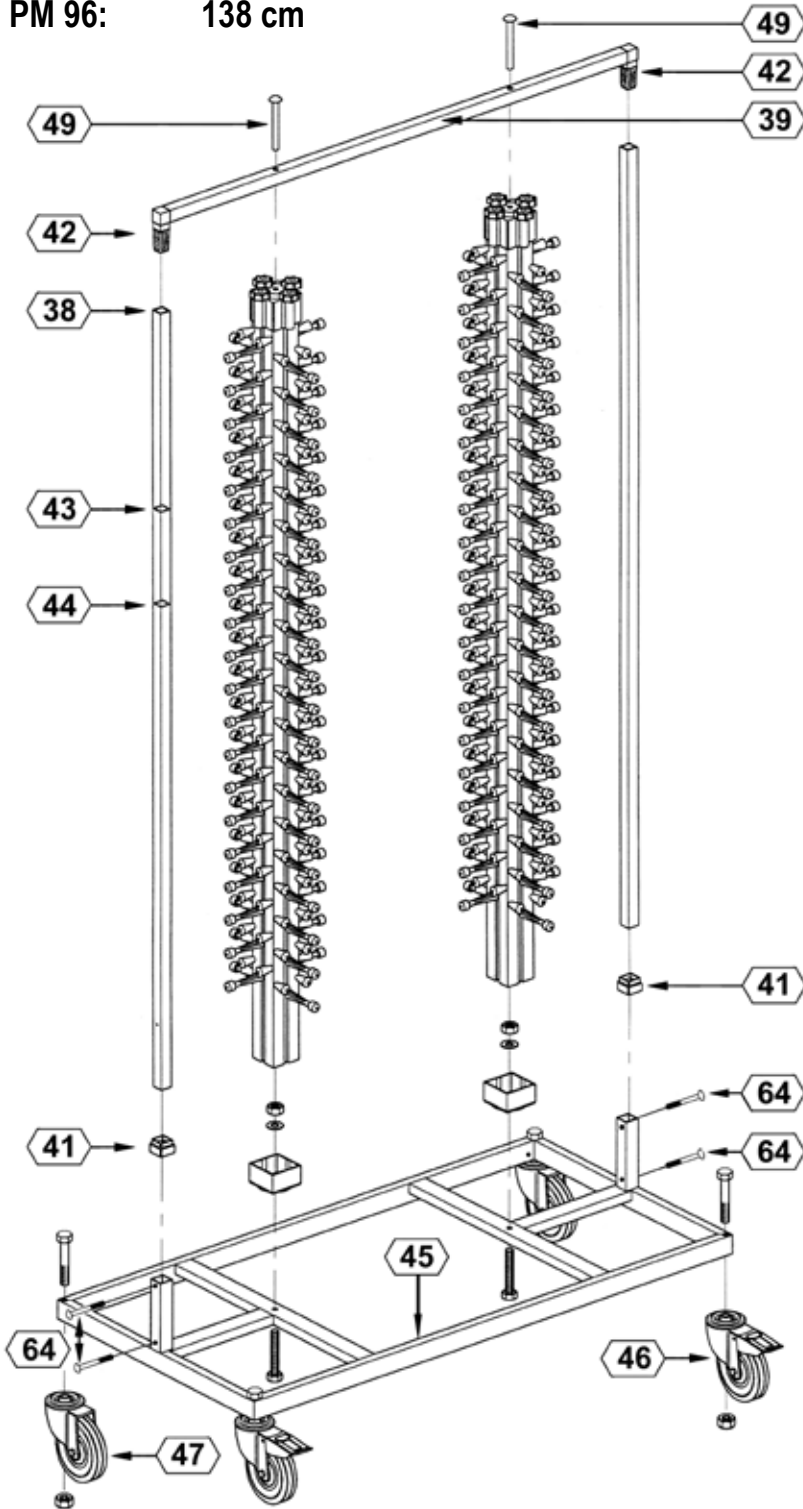

SIZE FRAME UNDERCARRIAGE: 60 x 120 cm

7 oktober 2013



PM TWIN 168 / CODE 180
PM TWIN 120 / CODE 170
PM TWIN 96 / CODE 160

PM TWIN



TOTAL HEIGHT:

- TM 12: 49 cm
- TM 24: 73 cm
- TM 36: 93 cm
- TM 48: 114 cm

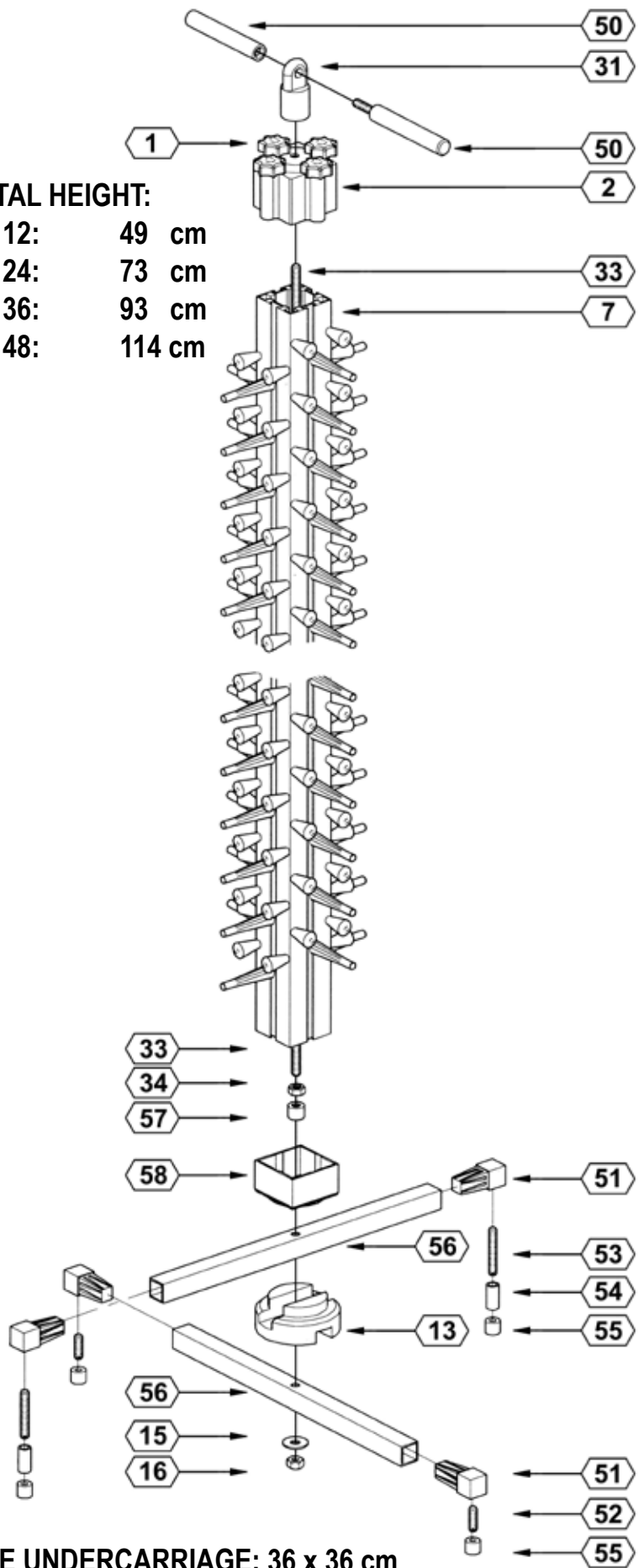

SIZE UNDERCARRIAGE: 36 x 36 cm

18 september 2012



- TM 12 - CODE 230
- TM 24 - CODE 220
- TM 36 - CODE 210
- TM 48 - CODE 200

TABLE MODEL



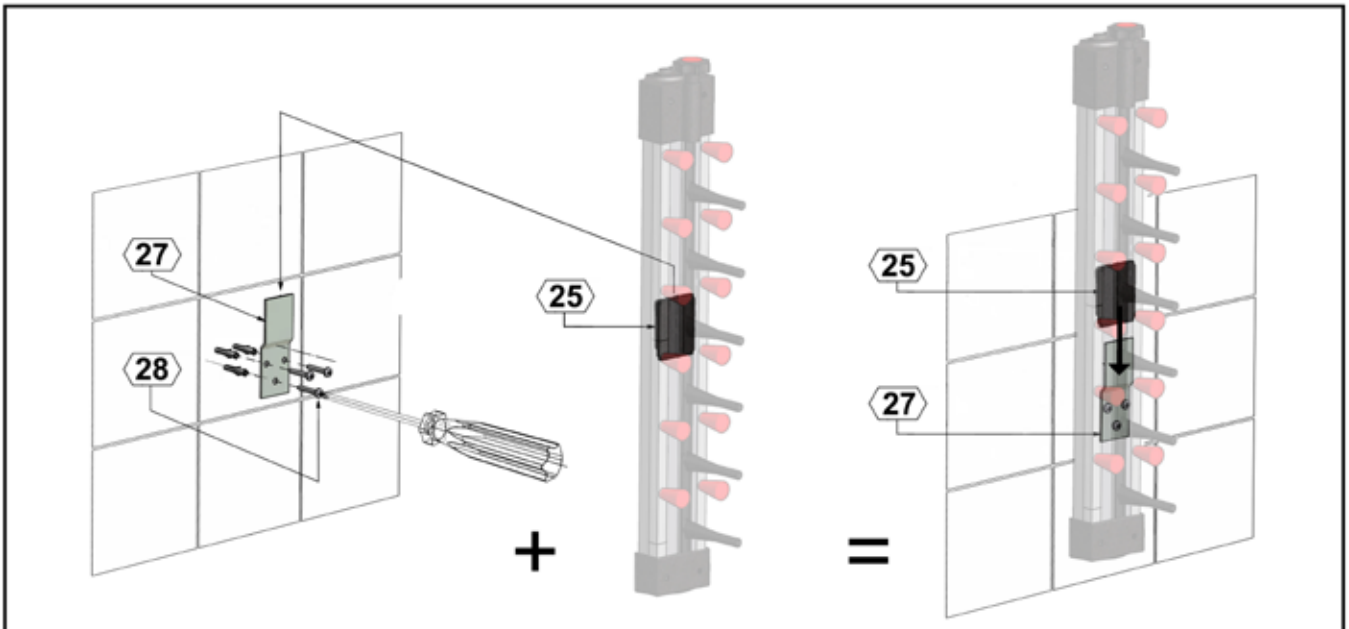

TOTAL HEIGHT:

57 cm

77 cm

99 cm

141 cm

162 cm

WIDTH:

7 cm

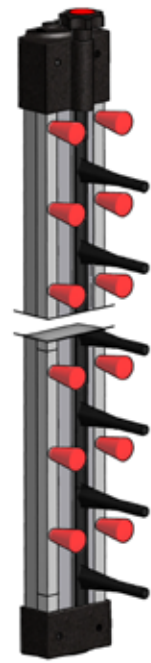
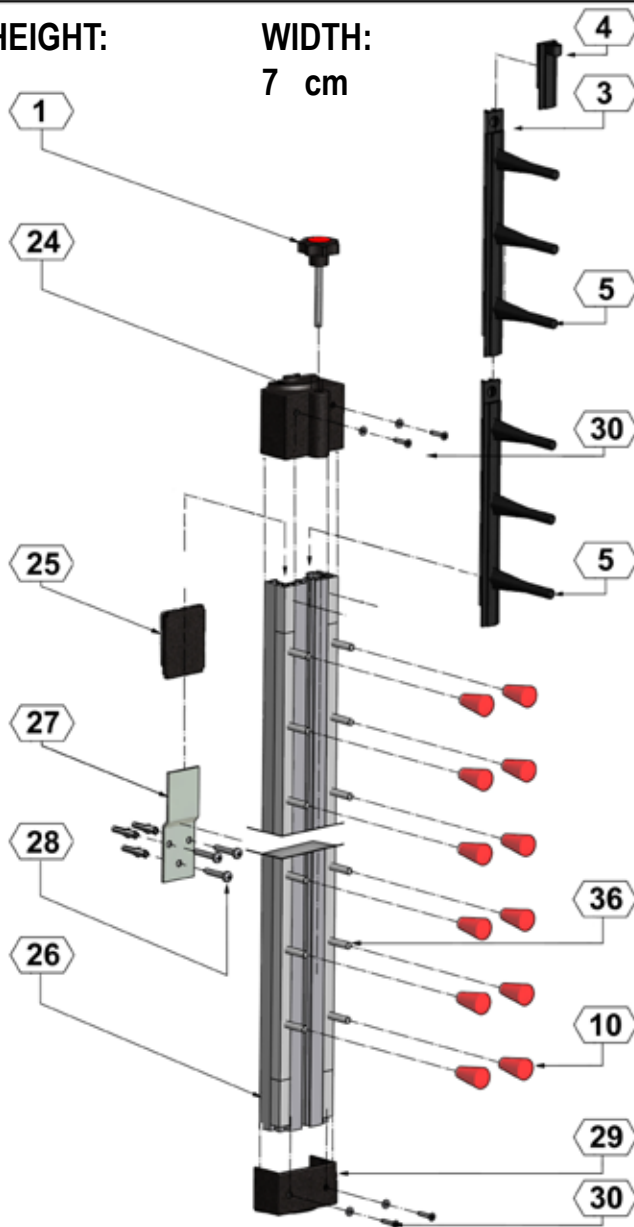

- WM 6 - CODE 370**
- WM 9 - CODE 360**
- WM 12 - CODE 350**
- WM 18 - CODE 340**
- WM 21 - CODE 330**

WALL MODEL



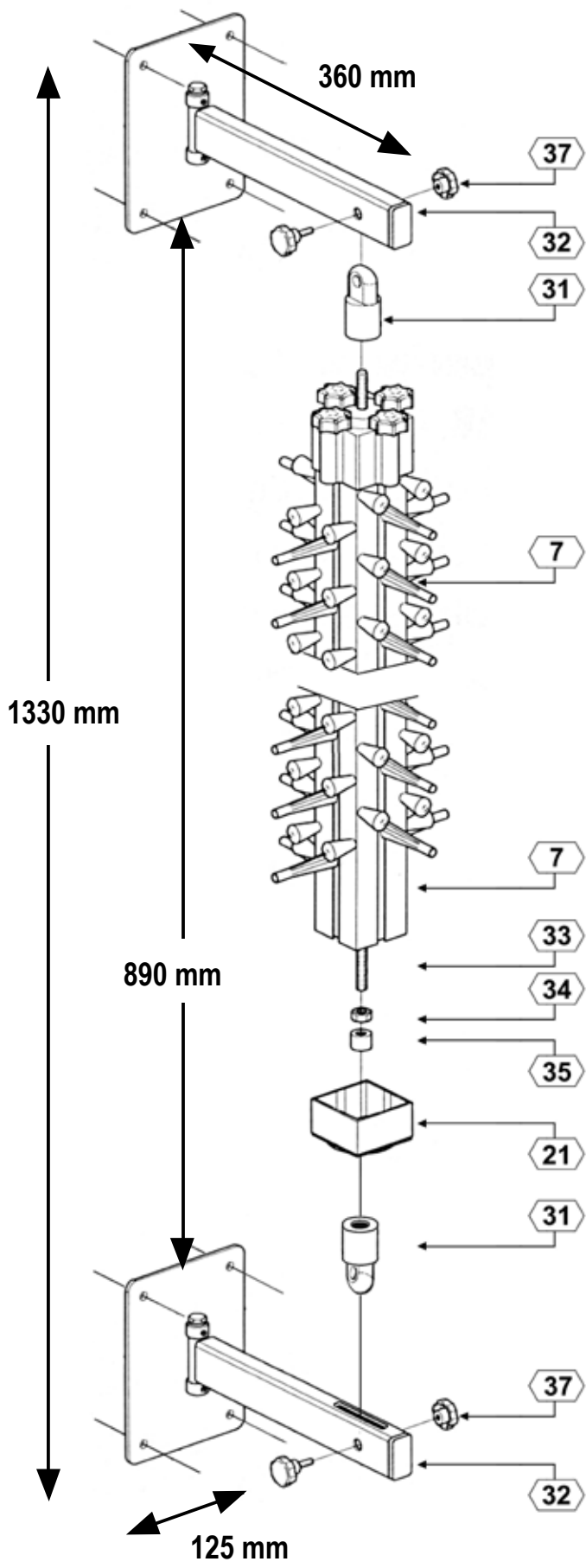

7 oktober 2013

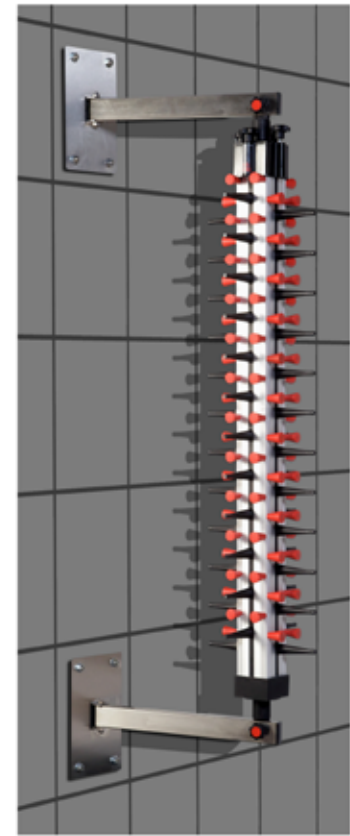

WM 48 - CODE 300
+ (2X) CODE 820 LM
WALL MODEL



- 1 Adjusting screw M6 x 60
- 2 Plastic hood COLUMN / TABLE MODEL
- 3 Extension hoisting block
- 4 Hoisting block
- 5 Black bracket (with three fingers)
- 6 Black stay cap
- 7 Aluminium main column
- 8 Corner extension piece grey 44 mm
- 9 Grey corner bracket Left or Right (marked with R or L)
- 10 Red shuttle
- 11 Corner extension piece grey 95 mm
- 12 Plastic foot (hole 10 mm)
- 13 Nylon fastening block
- 14 Connecting screw M10 x 40 mm
- 15 Washer 30 x 10 mm
- 16 Nut self-locking M10
- 17 Compression spring set
- 18 Plug in caps black
- 19 Centering pin M10 x 120 mm
- 20 Stainless steel inner frame
- 21 Stainless steel outer frame
- 22 Castor with brake, 100 mm
- 23 Castor without brake, 100 mm
- 24 Plastic hood WALL MODEL
- 25 Plastic wall clip
- 26 Aluminium column WALL MODEL
- 27 Stainless steel fastening clip
- 28 Plugs and screws for stainless steel fastening clip
- 29 Plastic foot WALL MODEL
- 30 Set of fasteners Foot / Hood WALL MODEL
- 31 Suspension eye
- 32 Stainless steel WALL MODEL support arm
- 33 Threaded rod
- 34 Nut M10
- 35 Spacer M10 WALL MODEL 48
- 36 Grey WALL MODEL bracket
- 37 Adjusting screw wall support
- 38 Stainless steel tube 84
- 39 Stainless steel upper tube TWIN
- 40 Stainless steel upper tube STANDARD and TWIN
- 41 Slip on caps
- 42 Corner connecting piece
- 43 Stainless steel tube 60 Twin
- 44 Stainless steel tube 48 Twin
- 45 Stainless steel under frame Twin
- 46 Castor with brake, 125 mm
- 47 Castor without brake, 125 mm
- 48 Stainless steel under frame, PM 84 STANDARD
- 49 Centering pin M10 x 70 mm
- 50 Nylon hand grip
- 51 Plug in foot
- 52 Adjusting bolt for foot, short 30 mm
- 53 Adjusting bolt for foot, long 60 mm
- 54 Spacer for feet
- 55 Rubber cap
- 56 Stainless steel tube TABLE MODEL
- 57 Spacer M10 TABLE MODEL
- 58 Plastic foot - hole 21.5 mm TABLE MODEL
- 64 Stainless steel bolt, 3,5 x 19 mm, connecting uppertube and undercarriage.

PART - LIST



The Original

